

Domestic Electromagnetic Spectrum Operations (DEMSO)



Resiliency Guide 2022

This document is a collaborative product of the San Antonio Electromagnetic Defense (SA-EMD), Domestic Electromagnetic Spectrum Operations Working Group.

Distribution A: Approved for public release; distribution unlimited

Certification and Signatures

We, the Domestic Electromagnetic Spectrum Operations (DEMSO) Steering Committee of the San Antonio Electromagnetic Defense (SA-EMD), certify that this guide captures the results obtained from the analysis and study of Electromagnetic Defense for Joint Base San Antonio and the City of San Antonio Metropolitan Area.



Mr. Guy Walsh
University of Texas at San Antonio
NSCC/Executive Director
San Antonio, Texas



Dr. John Huggins
University of Texas at San Antonio
NSCC/Technology Officer
San Antonio, Texas



Dr. Patricia Geppert
Radiance Technologies/JBSA-5G
Bioinformatics and Data Analytics Lead
San Antonio, Texas



TSgt Blanche Dudoit
502nd Air Base Wing
JBSA-EDI & 5G, Senior Analyst
Joint Base San Antonio, Texas



Mr. Michael J. Lovell
DAF, 502nd Air Base Wing
JBSA-EDI & 5G, Executive Director
Joint Base San Antonio, Texas

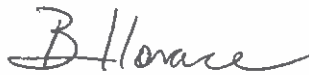

Ms. Briza M. Horace
DAF, 502nd Air Base Wing
JBSA-EDI & 5G, Deputy Director
Joint Base San Antonio, Texas

Disclaimer

Opinions, conclusions, and recommendations expressed or implied within are solely those of the authors and do not necessarily represent the views of the Department of Defense, the United States Air Force, Air Education and Training Command, the Department of Homeland Security, or any other US government agency.

Cleared for public release: distribution unlimited.



For information on the JBSA-EDI Pilot Project, contact:

Mr. Michael (Apollo) Lovell
michael.lovell.3@us.af.mil

or

Ms. Briza Horace
briza.horace.1@us.af.mil

Foreword

Joint Base San Antonio (JBSA) formed the San Antonio Electromagnetic Defense (SA-EMD), a partnership of Alamo Region communities and military entities to enable research and collaboration to improve critical infrastructure resiliency. SA-EMD obtains staff support from the Joint Base San Antonio-Electromagnetic Defense Initiative (JBSA-EDI) which is a pilot project to build infrastructure resiliency toward electromagnetic events and ensure JBSA continues operations in a post-Electromagnetic Pulse (EMP) environment. The Domestic Electromagnetic Spectrum Operations (DEMSO) Work Group is one of four work groups chartered through SA-EMD, to increase military and civilian resiliency to electromagnetic events. Electromagnetic resiliency increases survivability and mitigates the effects of an electromagnetic event on San Antonio. The following applies for this DEMSO Guide:

- The primary threats are High-altitude Electromagnetic Pulse (HEMP) and Geomagnetic Disturbance (GMD)
- It is an assumption that the power will go out
- The amount of time without power will exceed consumption of on-hand supplies which requires resupply preplanning (i.e.; food, water, fuel, etc.)
- The significant wide-area impact of HEMP and GMD will preclude support from existing mutual aid agreements
- The geographic area covered within this effort includes JBSA and the City of San Antonio Metropolitan Statistical Area¹

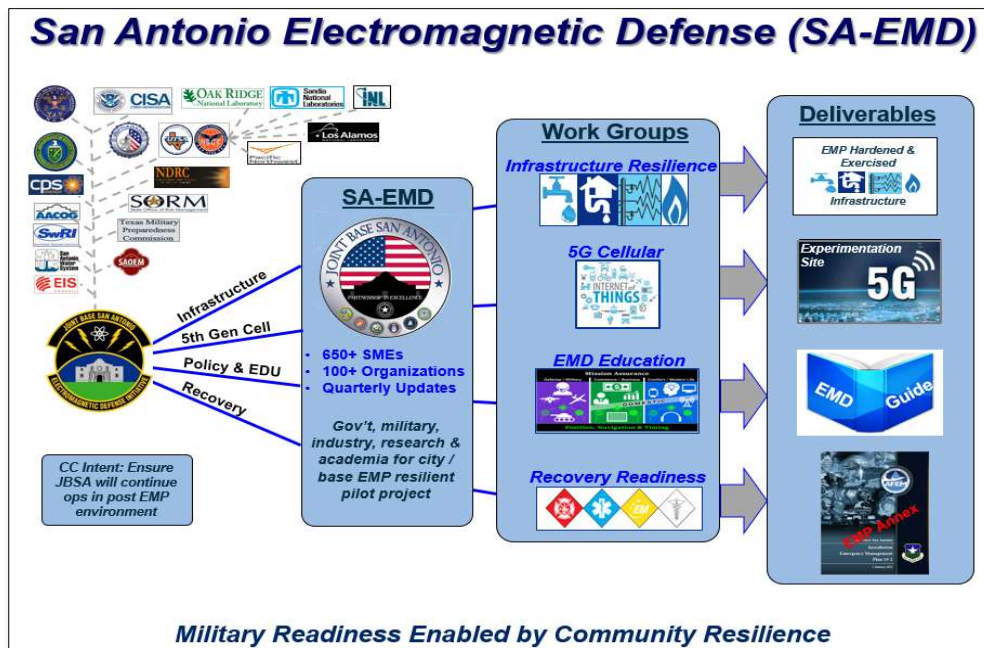

Figure 1: DEMSO Work Group is one of four work groups chartered through SA-EMD, in a quarterly public forum chaired by the Joint Base San Antonio (JBSA) Commander to collaborate with local and state government, academia, the military and industry.

¹ https://www2.census.gov/geo/maps/econ/ec2012/cbsa/EC2012_310M200US41700M.pdf

Executive Summary

The Domestic Electromagnetic Spectrum Operations (DEMSO) Resiliency Guide addresses high-altitude electromagnetic pulses (HEMP) and destructive solar-induced geomagnetic disturbances (GMD) as emerging threats to San Antonio. Collectively, these threats will be referred to as the EMP threat and are capable of permanently disabling critical systems and equipment that enable the operations and functionality of society.

The Department of Defense (DoD) is intimately familiar with electromagnetic defense of military assets due to their global mission. Even installations prepared to respond to EMP threats rely on several critical infrastructures (i.e.; energy, water/waste, communications, finance, etc.) which are primarily owned and operated by the private sector. Additionally, the majority of DoD employees live off base, therefore an electromagnetic impact to the local community will impact the installation. Expanding infrastructure resiliency efforts “outside the wire” acknowledges the reality that mission readiness is enabled by community resiliency.

When it comes to community resiliency, a challenging aspect to preparedness planning is the interdependencies between our nation’s sixteen critical infrastructure sectors. As witnessed during recent large-scale disasters, impact to infrastructure within the Communications, Energy, Water/Waste, or Transportation Sectors leads to cascading effects across all critical infrastructure sectors. This is especially true for the Energy Sector. In February 2021, during Winter Storm Uri, operators of the Texas electrical grid reported being within minutes of an entire system collapse which would require a “black start.” This is a process of gradually rebuilding the grid by restarting individual power generation plants which could take weeks or months to implement.² The aftermath of an electromagnetic event has similarities. While some critical services are expected to cease immediately following an electromagnetic event, other sectors will rapidly degrade within hours and days of initial impact. In a post-EMP environment, experts estimate long-term regional power outages could last weeks or months.³ In this case, it should not be assumed that mutual aid support, such as the Emergency Management Assistance Compacts (EMAC), will be an available response option.

DEMSO leveraged a robust public-public, public-private (P4) partnership between JBSA and the community to develop this resiliency guide. The guide is part of a phase one approach focused on the San Antonio and South-Central Texas area to inform senior leaders of critical infrastructure within the base and community, as well as Presidents and Superintendents of academia and businesses. Phase two will include lessons learned to be shared with military/civilian communities with significant DoD presence. The goal of phase one is to promote resiliency by providing the analysis of policy and education, and presenting an EMP/GMD Resiliency Maturity Model. Lastly, the guide offers recommendations to initiate or strengthen engagement within the community to incorporate response to EMP threats into existing preparedness processes.

² Cascading risks: Understanding the 2021 winter blackout in Texas, Energy Research & Social Science, Vol 77, 2021, 102106, ISSN 2214-6296, <https://doi.org/10.1016/j.erss.2021.102106>

³ <https://www.govinfo.gov/content/pkg/CHRG-113hhr89763/html/CHRG-113hhr89763.htm>

Acknowledgements

The completion of this project could not have been possible without the local, regional, and national volunteers that assisted with and participated in, the myriad of valuable discussions contributing to the overall Domestic Electromagnetic Spectrum Operation's working group's efforts.

We would also like to thank Joint Base San Antonio and the National Security Collaboration Center at the University of Texas at San Antonio, for providing our work group the necessary resources for the duration of our endeavor. Our thanks and appreciation also go to the teams of CPS Energy, San Antonio Water System, the San Antonio Office of Emergency Management, Southwest Research Institute, VIA Transportation, and the InfraGard National Disaster Resilience Council for their remarkable hospitality, support, and partnership.

Lastly, we want to express our sincere appreciation to all of our SA-EMD volunteers – your collaboration, insight and willingness to demonstrate the art of the possible, continues to make an incredible difference in building resilience in San Antonio, Texas and our great nation.

Contributors:

Mr. Tim Carty
EMP Shield

Lt Col Steve Chill, USMC (ret)

Mr. John Courtenay
STRATCOM JEW EWW

Dr. Plamen Doynov
EMP Shield

TSgt Blanche Dudoit, USAF
JBSA-EDI, TXANG

Dr. Patricia Geppert
JBSA-5G

Mr. Rex G. Haddix II, DCE/DCM
MITRE Corp

Ms. Briza Horace
JBSA-EDI & 5G

Dr. John Huggins
UTSA/NSCC

Mr. Jody Little
JBSA-5G

Mr. Michael "Apollo" Lovell
JBSA-EDI & 5G

Mr. Henry Newton, P.E.
NDRC & Louisiana InfraGard Founding President

Lt Col Eddie "Thumper" Stamper, USAF (ret)
Founder, JBSA-EDI

Dr. Gregory White
UTSA/CIAS

Mr. Timothy C. White, P.E.
CACI

Table of Contents

Certification and Signatures.....	2
Disclaimer	3
Foreword.....	4
Executive Summary	5
Acknowledgements.....	6
1. Introduction.....	9
2. Threat Overview	11
2.1 Geomagnetic Disturbance (GMD).....	11
2.2 High-altitude Electromagnetic Pulse (HEMP).....	11
3. Policy Overview.....	12
3.1 Federal Policy.....	13
3.2 Policy Analysis & Gaps	15
3.2.1 ESF vs. CIS.....	16
3.2.2 Regulatory Environment.....	17
3.2.3 Sector Interdependencies	18
3.2.4 Supply Chain.....	19
4. EMP Resiliency Maturity Model.....	21
4.1 Mission Areas.....	22
4.1.1 Awareness	23
4.1.2 Protection	23
4.1.3 Mitigation.....	24
4.1.4 Response	24
4.1.5 Recovery	24
4.2 Organizational Levels	25
4.2.1 Individual/Family.....	25
4.2.2 Organization.....	27
4.2.3 Community	28
4.2.4 Local Government	30
4.2.5 State Government.....	31
5. EMP Resiliency Education	32
5.1 Elements of EM Resiliency Education Curriculums.....	32
5.1.1 Public Service Campaigns	33

5.1.2	Individual/Family.....	33
5.1.3	Organizations	33
5.1.4	Community	33
5.1.5	Local Government	34
5.1.6	Additional Education	34
5.1.7	Recommended Reading	34
6.	Conclusions.....	35
7.	Recommendations.....	36
8.	Other Relevant Documents.....	39
9.	Glossary of Acronyms and Abbreviations.....	41
	Appendix – A: Doctrine Overview	43
	Appendix – B: Electromagnetic Countermeasures	46

1. Introduction

In 1859, the world experienced an event unlike any other in recorded history. What is now known as the Carrington Event, was the most powerful recorded solar storm to impact Earth, witnessed by British astronomer Richard Carrington through the protective dark filtered lens of a telescope. Within a day of observing bright flashes from sunspots, news sources reported events and phenomenon that are directly attributed to electromagnetism. Auroras were seen as far south as the Caribbean and they were reported to be so bright, people could read newspapers by their light. Metal fences were seen arcing with electricity and telegraph operators reported equipment rendered useless while others reported fires.⁴

A much smaller-scale event occurred in 1989. Within days of a massive explosion on the sun, electrical currents surged throughout great portions of North America. The entire Quebec energy grid lost power in under two minutes. As the Quebec grid went down, New York Power and the New England Power Pool lost significant amounts of energy. In the United States, a little under 100 utilities experienced service interruptions and over 200 power grid problems emerged from coast to coast. Back in Quebec, the beginning of a 12-hour blackout began. Millions of people were surrounded by darkness in offices, trapped in underground pedestrian systems, and suspended in elevators. Schools, businesses, the metro and airport were forced to close.⁵

Unlike the Carrington Event or the Quebec Blackout, today the United States has access to cutting-edge technology that predicts, detects, and notifies us of potential solar storms. The gift of time; however, does not ensure a resilient system. The infrastructure within the United States power grids is dated and continues to age. Vulnerable transformers are not easily repaired or replaced, there are limited supplies in inventory, and the majority of large transformers are produced overseas (requiring an approximate 18-month lead time from order to installation). Additionally, today's most vital communications (including financial transactions) rely heavily on earth orbiting satellites for position, navigation and timing.

A no-notice regional or national level EMP event created by a high-altitude EMP (nuclear weapon) has similar impacts, except without warning. These impacts could lead to power outages lasting weeks to months. This threat capability not only exists today, but it also continues to proliferate.

⁴ Christopher Klein, A Perfect Solar Superstorm: The 1859 Carrington Event, History, 3/14/2012

⁵ Dr. Sten Odenwald, The Day the Sun Brought Darkness, NASA, 03/13/2009

Several congressional studies^{6,7,8,9}, Federal agency and military assessments^{10,11,12,13}, and strategic policy think tanks^{14,15}, concluded that the U.S. is woefully unprepared to deal with either a HEMP or GMD event.

In March 2019, the President of the United States signed Executive Order 13865 to Coordinate National Resilience to EMP. “The policy is to prepare for the effects of EMPs through targeted approaches that coordinate whole-of-government activities and encourage private-sector engagement.”¹⁶ DEMSO supports the order by accelerating the effort to expedite resiliency building from the local level.

⁶ T. S. Popik, G. H. Baker and W. R. Harris, "Electric Reliability Standards for Solar Geomagnetic Disturbances: Comments submitted to the Federal Energy Regulatory Commission," Commission to Assess the Threat to the United States from Electromagnetic Pulse (EMP) Attack, Washington D.C., July 2017.

⁷ D. P. V. Pry, "Nuclear EMP Attack Scenarios and Combined-Arms Cyber Warfare," Commission to Assess the Threat to the United States from Electromagnetic Pulse (EMP) Attack, Washington D.C., July 2017.

⁸ D. W. R. Graham, "Report to the Commission to Assess the Threat to the United States from Electromagnetic Pulse (EMP) Attack," Commission to Assess the Threat to the United States from Electromagnetic Pulse (EMP) Attack, Washington D.C., July 2017.

⁹ "Assessing the Threat from Electromagnetic Pulse (EMP): Executive Report," Commission to Assess the Threat to the United States from Electromagnetic Pulse (EMP) Attack, Washington D.C., July 2017.

¹⁰ "Written testimony of National Protection and Programs Directorate Infrastructure Analysis and Strategy Division Director Brandon Wales for a House Committee on Homeland Security, Subcommittee on Cybersecurity, Infrastructure Protection, and Security Technologies hearing titled “The Electromagnetic Pulse (EMP) Threat: Examining the Consequences.”," Department of Homeland Security, Arlington, Virginia, September 12, 2012.

¹¹ Committee on Enhancing the Robustness and Resilience of Future Electrical Transmission and, Terrorism and the Electric Power Delivery System - 2010 NAP - Book, Washington D.C.: National Research Council, 2012.

¹² "Strategy for Protecting and Preparing the Homeland Against Threat of EMP and Geomagnetic Disturbances," Department of Homeland Security (DHS), 2018.

¹³ D. Stuckenberg, R. J. Woolsey and D. DeMaio, "Electromagnetic Defense Task Force (EDTF) 2.0 2019 Report," LeMay Center for Doctrine Development and Education, Montgomery, 2019.

¹⁴ J. Carafano and R. Weitz, "EMP Attacks—What the U.S. Must Do Now," The Heritage Foundation, November 17, 2010.

¹⁵ "Strategic Primer: Electromagnetic Threats - Current Capabilities and Emerging Threats," The American Foreign Policy Council, Vol 4, Winter 2018.

¹⁶ Executive Order (EO) 13865, Coordinating National Resilience to Electromagnetic Pulses, 26 March 2019, 3 C.F.R. 1, <https://www.federalregister.gov/documents/2019/03/29/2019-06325/coordinating-national-resilience-to-electromagnetic-pulses>.

2. Threat Overview

This threat overview is not intended to provide the reader with an exhaustive analysis of electromagnetic threats, but rather to frame and assess the threats to highlight the need for policy and education focused on resiliency. Without solid understanding of electromagnetic threats, it is impossible to build plans that enable organizations and communities to protect, mitigate, respond and recover from these catastrophic events. Various reports, such as those produced by the Congressional EMP Commission, provide in-depth assessments of EMP threats and their impact on society.

2.1 Geomagnetic Disturbance (GMD)

Solar storms are naturally occurring space weather events that produce coronal mass ejections (CME) which can travel through space toward Earth. When charged particles from CME's hit Earth's magnetosphere and ionosphere, they create a geomagnetic disturbance (GMD) that affect satellites, power grids, communications, navigation, and more (as shown in Figure 2.1).

When CME induced GMD's impact the power grid, they can overheat high voltage transformers to the point of irreversible damage. As critical components of power transmission, damaged transformers can lead to wide-spread power outages. Although space weather events occur often, the severity is generally low and there is little to no impact on our daily lives, particularly communities with close proximity to the equator. However, researchers estimate that the chances of a large-scale GMD event are as high as 12% every decade.¹⁷

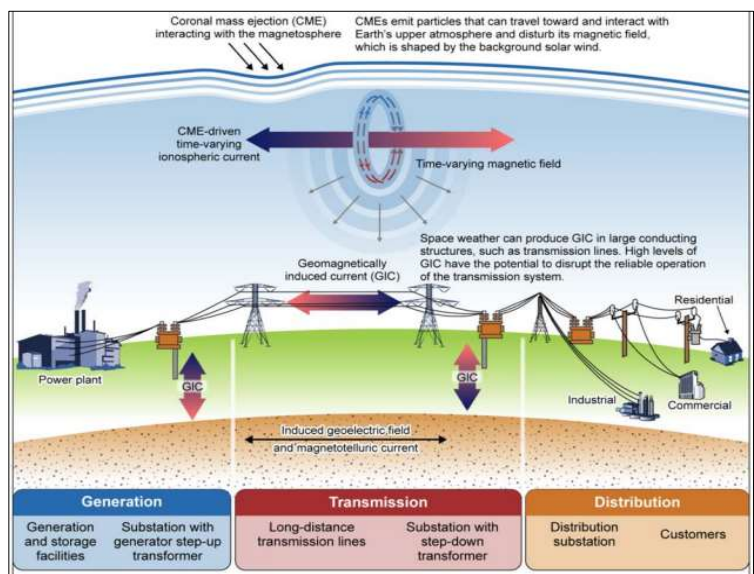

Figure 2.1: NERC, TPL-007-2, GMD Outage Description¹⁸

2.2 High-altitude Electromagnetic Pulse (HEMP)

An electromagnetic pulse can be generated by detonating a nuclear weapon in the upper atmosphere. Often referred to as HEMP, the event simultaneously generates multiple waveforms that vary in timing, duration, power and wavelength. The waveforms are broken into three phases, E1, E2 and E3 (as shown in Figure 2.2). The first phase, E1 is characterized by a high

¹⁷ Riley, P. (2012), On the probability of occurrence of extreme space weather events, Space Weather, 10, S02012, doi:10.1029/2011SW000734

¹⁸ http://www.ercot.com/content/wcm/key_documents_lists/180164/BMCD_GMD_TPL_007_Outage_Descriptions_Presentation_05-16-2019.pdf

amplitude, extremely short duration signal capable of overwhelming and destroying semiconductors embedded in electronics. The leaner, faster, high-capacity micro-circuits within modern devices are especially vulnerable. The E2 phase consists of electromagnetic waves similar in intensity and duration to waves generated by lightning strikes. Although E2 waves can be destructive, our society appears to be protected against E2 due to commonly installed lightning suppression systems. Lastly, E3 signals are characterized as being similar to a GMD, with lower amplitudes and much longer durations than the E1 and E2 elements. E3 waves tend to impact infrastructure connected to long conductors such as power lines, metal pipelines, or even railroads.

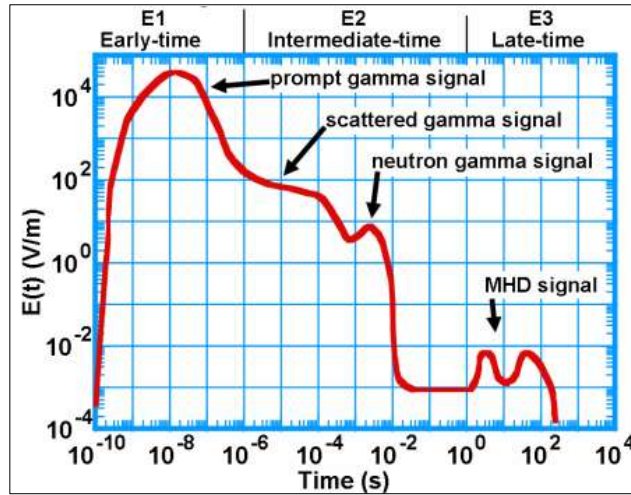

Figure 2.2: Generic EMP Signal Components ¹⁹

3. Policy Overview

EMP events are currently classified under “all-hazards” events as defined by Federal Emergency Management Agency (FEMA) in the Federal Continuity Directive 1²⁰. Due to this classification, planned response to EMP threats resemble responses to hurricanes, earthquakes, and other large-scale events. Local small-scale incidents are typically managed by local authorities with local assets, and larger responses are managed by state level authorities with state assets. During larger-scale responses, if the support requests exceed the state level capabilities, Federal support can be requested. This model is effective for most incidents with local impacts; however, they may not be effective for EMP events where communications and coordination is severely degraded and outside support is not available. In such an event, communities will be required to operate independently.

¹⁹ Radasky, W. et al (2010), High-Frequency Protection Concepts for the Electric Power Grid, Metatech, Meta-R-324

²⁰ <https://www.gpo.gov/docs/default-source/accessibility-privacy-coop-files/January2017FCD1-2.pdf>

3.1 Federal Policy

The following Federal policies are helpful in understanding the current response apparatus. Armed with this understanding, commanders and community leaders may plan and coordinate EMP/GMD resiliency efforts without having to “start from scratch”.

Stafford Act: The Stafford act authorizes Federal funding (and Federal support) to states for emergencies. The support, however, is not automatic. It must be requested by the state and approved at the Federal level.

Presidential Policy Directive-21, Critical Infrastructure Security and Resilience (Feb 2013): PPD-21 established the 16 Critical Infrastructure Sectors “whose assets, systems, and networks, whether physical or virtual, are considered so vital to the United States that their incapacitation or destruction would have a debilitating effect on security, national economic security, national public health or safety, or any combination thereof.”²¹ PPD-21 also appointed the Sector Specific Agencies (SSA) accountable for each sector. SSAs are the “Federal department or agency designated to be responsible for providing institutional knowledge and specialized expertise as well as leading, facilitating, or supporting the security and resilience programs and associated activities of its designated critical infrastructure sector in the all-hazards environment.”²² The sectors are listed below with their respective SSA.

<u>Critical Infrastructure Sector (CIS)</u>	<u>Sector-Specific Agency (SSA)</u>
Chemical	DHS
Commercial Facilities	DHS
Communications	DHS
Critical Manufacturing	DHS
Dams	DHS
Defense Industrial Base	DoD
Emergency Services	DHS
Energy	DOE
Financial Services	Department of Treasury
Food and Agriculture	USDA/DHHS
Government Facilities	DHS/GSA
Healthcare and Public Health	DHHS
Information Technology	DHS
Nuclear Reactors, Materials, and Waste	DHS
Transportation Systems	DHS/DOT
Water and Wastewater Systems	EPA

Presidential Policy Directive-8, National Preparedness (Mar 2011):

PPD-8 directed the development of the National Preparedness Goal and the National Preparedness System. National Planning Frameworks guide activities that support the Nation’s efforts to achieve the National Preparedness Goal. The Preparedness Goal is achieved through core capabilities

²¹ CISA Critical Infrastructure Sectors. <https://www.cisa.gov/critical-infrastructure-sectors>

²² Presidential Policy Directive-Critical Infrastructure Security and Resilience, PPD-21

broken into five preparedness mission areas. Each mission area has a planning framework and a separate Federal Interagency Operational Plan. The five preparedness mission areas are as follows:

Prevention: Prevent, avoid or stop an imminent, threatened or actual act of terrorism.

Protection: Protect our citizens, residents, visitors, and assets against the greatest threats and hazards in a manner that allows our interests, aspirations and way of life to thrive.

Mitigation: Reduce the loss of life and property by lessening the impact of future disasters.

Response: Respond quickly to save lives, protect property and the environment, and meet basic human needs in the aftermath of a catastrophic incident.

Recovery: Recover through a focus on the timely restoration, strengthening and revitalization of infrastructure, housing and a sustainable economy, as well as the health, social, cultural, historic and environmental fabric of communities affected by a catastrophic incident.”²³

Within the National Response Framework are Emergency Support Functions (ESF) that “describe Federal coordinating structures that group resources and capabilities into functional areas most frequently needed during a national response.”²⁴ The 15 ESFs are listed below with their Federal coordinating agencies indicated.

<u>ESF</u>	<u>Functional Area</u>	<u>Federal Coordinating Agency</u>
ESF #1	Transportation	DOT
ESF #2	Communications	DHS/Nat’l Comm System
ESF #3	Public Works and Engineering	DOD/USACE
ESF #4	Firefighting	USDA/Forest Service
ESF #5	Information and Planning	DHS/FEMA
ESF #6	Mass Care, Emergency Assistance, Housing & Human Services	DHS/FEMA
ESF #7	Logistics	GSA & DHS/FEMA
ESF #8	Public Health and Medical Services	DHHS
ESF #9	Search and Rescue	DHS/FEMA
ESF #10	Oil and Hazardous Materials Response	EPA
ESF #11	Agriculture and Natural Resources	USDA
ESF #12	Energy	DOE
ESF #13	Public Safety and Security	DOJ
ESF #14	Cross-Sector Business & Infrastructure	DHS/CISA
ESF #15	External Affairs	DHS/FEMA

²³ FEMA Mission Areas and Core capabilities. <https://www.fema.gov/emergency-managers/national-preparedness/mission-core-capabilities>

²⁴ <https://www.fema.gov/emergency-managers/national-preparedness/frameworks/response>

Department of Defense Directive 3025.18, Defense Support to Civil Authorities (DSCA) (Mar 2018):

DSCA is initiated by a request from civil authorities or qualifying entities or is authorized by the President or Secretary of Defense. Unless otherwise delegated, all DSCA requests requires approval from the Secretary of Defense. Requests will be evaluated for legality, lethality, risk, cost, appropriateness and readiness, and responses are compatible with PPD-8. Additionally, under this directive, Federal military commanders are provided “immediate response authority” and “emergency authority” as described below.²⁵

Immediate Response Authority: Given to Federal military commanders during imminently serious conditions and when time does not permit approval from higher authority. In these circumstances, commanders may provide an immediate response by employing the resources under their control, to save lives, prevent human suffering, or mitigate great property damage. If response activities have not ended, the official directing the response must reassess necessity for DoD assistance under this authority no later than 72 hours after the request was received.

Emergency Authority: Federal military forces are not to be used to quell civil disturbances unless authorized by the President. In extraordinary emergency circumstances, where prior authorization by the President is impossible and duly constituted local authorities are unable to control the situation, commanders have the authority to engage temporarily in activities that are necessary to quell large-scale, unexpected civil disturbances. Examples are activities to prevent significant loss of life or wanton destruction of property and are necessary to restore governmental function and public order, or when duly constituted authorities are unable or decline to provide adequate protection for Federal property or Federal governmental functions. Federal action, including the use of Federal military forces, is authorized when necessary to protect the Federal property or functions.

3.2 Policy Analysis & Gaps

Although the existing frameworks suit most responses to local incidents, the frameworks are dependent on adequate communication and coordination amongst entities. There is a need for greater consideration of likely nationwide impacts following EMP events such as destroyed communications or other incapacitated critical infrastructures. Additionally, there are several challenges that must be discussed regarding connections between roles and policies of Federal agencies. Such challenges include complicated regulatory environments, sector interdependencies, and supply chain shortfalls.

Lastly, different authoritative bodies such as the DoD, DoE, DHS, and EPRI²⁶ may adopt conflicting standards for EMP resilient design and testing. It is prudent to avoid fixating on any single standard, and instead select a solution based on the threat/risk scenario most pertinent to an organization’s location and mission. As an example, infrastructure vital for national survivability

²⁵ <https://www.esd.whs.mil/Portals/54/Documents/DD/issuances/dodd/302518p.pdf>

²⁶ <https://www.epri.com/>

has a minimal acceptable risk level compared to infrastructure whose primary function provides retail products or university studies.

3.2.1 ESF vs. CIS

FEMA's National Response Framework is comprised 15 Emergency Support Functions (ESF), whereas CISA identifies 16 critical infrastructure sectors (CIS). Though the functions and sectors may have been created for different reasons, there is an inherent connection in these programs to achieve resiliency. If the functions and sectors were organized through a complimentary method, it may enable additional funding opportunities and collaboration.

Should FEMA include EMP/GMD or long-term regional power outages as a National Planning Scenario, it would emphasize the need for deliberate planning to overcome these risks. Similarly, should the Sector Specific Plans (SSP) be updated to comply with the 2013 National Infrastructure Protection Plan (NIPP) "Call to Action #2"²⁷, there would be an opportunity to align these frameworks and promote efficiency in planning efforts. Aligning updated Infrastructure Data Taxonomy with current critical infrastructure sectors will also be beneficial.²⁸

At a local level, JBSA and CoSA can bridge these gaps by leveraging partnerships across the community. To do so, JBSA and CoSA must understand who the primary coordinating responsibilities are. Table 3.1 best aligns the response framework with critical infrastructure sectors and identifies the primary coordinating responsibilities at Federal²⁹, Texas (State)³⁰ and San Antonio (local)³¹ levels. Within these existing partnerships and work groups, infrastructure across all levels can be cataloged and prioritized based on criticality. Although not every infrastructure sector is named within Table 3.1, the Chemical, Commercial Facilities, Critical Manufacturing, Defense Industrial Base, Financial Services, Government Facilities and Information Technology sectors are all critical with supporting roles and responsibilities.

²⁷ <https://www.cisa.gov/sites/default/files/publications/national-infrastructure-protection-plan-2013-508.pdf>

²⁸ <https://www.cisa.gov/cisa/infrastructure-data-taxonomy>

²⁹ https://www.fema.gov/sites/default/files/2020-04/NRF_FINALApproved_2011028.pdf

³⁰ https://tdem.texas.gov/wp-content/uploads/2019/08/2020-State-of-Texas-Basic-Plan_WEBSITE_05_07_gs.pdf

³¹ <https://www.saoemprepare.com/Portals/16/Files/Plans/BasicPlan.pdf>

Emergency Support Function (ESF)	Critical Infrastructure Sector: Lead Sector Specific Agency	ESF Lead Federal Coordinator	ESF Lead State Coordinator	ESF Lead City Coordinator
ESF #1: Transportation	Transportation Systems: DHS/DOT	DOT	TX DOT	EMC, Transportation Department Director, VIA, & ESC Region 20
ESF #2: Communications	Communications: DHS	DHS/CISA	TDEM	GPA Director
ESF #3: Public Works and Engineering	Dams, Water and Wastewater Systems: DHS/EPA	DOD/US Army Corps of Engineers	TX DOT	PWD Director & SAWS
ESF #4: Firefighting	Emergency Services: DHS	USDA/US Forest Service and DHS/FEMA/US Fire Admin	TX A&M Fire Svc	Fire Chief
ESF #5: Information and Planning		DHS/FEMA	TDEM	Mayor, City Manager & EMC
ESF #6: Mass Care, Emer Asst, Temp Housing and Human Svcs	Healthcare & Public Health: DHHS			
ESF #7: Logistics	(as applicable)	GSA and DHS/FEMA		EMC and Finance Director
ESF #8: Public Health and Medical Svcs	Healthcare & Public Health: DHHS	DHHS	TX DOS Health Svcs	SAMHD Director, PWD Director, DHS Director, & VOAD
ESF #9: Search and Rescue	Emergency Services: DHS	DHS/FEMA	TX A&M Engineering Extension Svc	Fire Chief
ESF #10: Oil and HAZMAT Response		EPA	TX Comm on Environ. Quality	
ESF #11: Agriculture and Natural Resources	Food & Agriculture: USDA/DHHS	USDA	TX Animal Health Commission	EMC and Finance Director
ESF #12: Energy	Energy and Nuclear Reactors, Materials & Waste: DOE/DHS	DOE	Public Utility Commission of TX	Finance Director, Public Utilities Division Director (CPS Energy)
ESF #13: Public Safety and Security	Emergency Services: DHS	DOJ/BATFE	TX DPS	Police Chief & EMC
ESF #14: Cross-Sector Business and Infrastructure	All Sectors	DHS/CISA	TDEM	Mayor, City Manager & EMC
ESF #15: External Affairs	(as applicable)	DHS		GPA

Table 3.1: Analysis of ESFs across Government and aligned with Critical Infrastructure

3.2.2 Regulatory Environment

The regulatory environment is very complex for the majority of the critical infrastructure sectors. This impacts roles and responsibilities for maintaining or improving the security and resilience of infrastructure. Although it varies for each sector, nearly all are affected by factors such as public versus private ownership, multiple authorities, sector specific threats and hazards, and decisions on how risk is measured or mitigated.³² As an example, Figure 3.1 reflects common jurisdictions within the electric grid of the Energy Sector. Power generation and transmission is regulated federally by the North American Electric Reliability Corporation (NERC) with oversight from the Federal Energy Regulatory Commission (FERC) and power distribution is regulated at the state level through Public Utility Commissions (PUC). Multiple regulators can also be seen in the Chemical Sector as shown in Table 3.2, which lists authorities that impact how chemicals are produced, stored, transported, sold and used. Since policies have a top-down approach, organizations and communities can expedite resiliency efforts with planning that starts with consideration of the higher-level policy.

³² A Guide to Critical Infrastructure Security and Resilience, Nov 2019

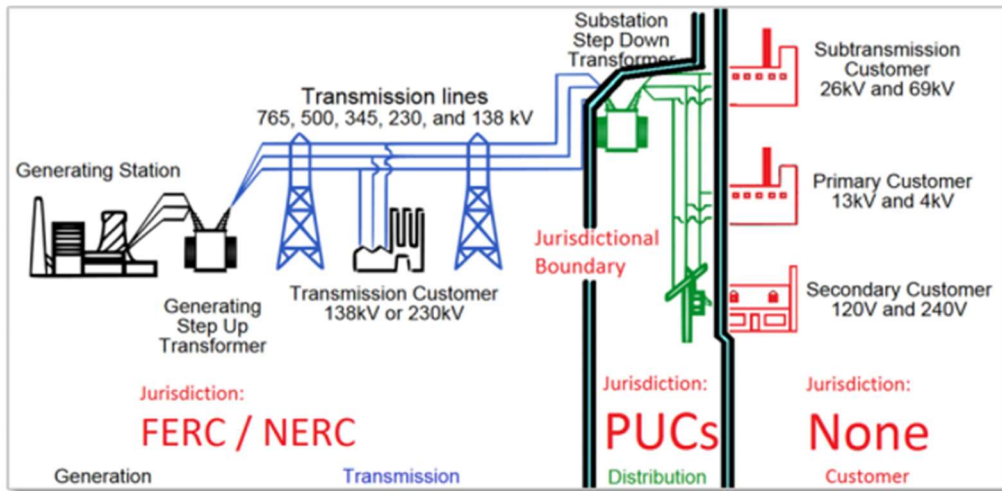

Figure 3.1: Electric Grid Jurisdictions³³

Executive Orders	EO 13650, Improving Chemical Facility Safety and Security EO, Strengthening the Cybersecurity of Federal Networks and Critical Infrastructure
DHS	Chemical Facility Anti-Terrorism Standards
	Ammonium Nitrate Security Program
	SAFETY Act
	Maritime Transportation Security Act
	Rail Transportation Security
DOJ	Controlled Substance Act
	Federal Explosives Laws
EPA	Chemical Safety Information, Site Security and Fuels Regulatory Relief Act
	Clean Water Act
	Emergency Planning and Community Right-to Know Act
	Safe Drinking Water Act
	Toxic Substances Control Act Chemical Testing Regulations
DOT	Federal Insecticide, Fungicide and Rodenticide Act
	Hazardous Materials Transportation Act
DOC	Federal Rail Safety
	Chemical Weapons Convention
DOS	Export Administration Regulations
	International Traffic in Arms Regulations

Table 3.2: Federal Authorities impacting Chemical Sector³⁴

3.2.3 Sector Interdependencies

Estimating the total impact of an EMP event is difficult due to the complex interdependencies between and within sectors. Table 3.3 attempts to visualize and organize these relationships. Although the network of relationships exists in a massive, complicated and interwoven web, the color blue is used to represent the primary interdependencies. The interdependencies that were identified by SSAs in the 2015 SSPs were analyzed and refined to develop the table which includes

³³ https://www.puc.texas.gov/industry/electric/reports/energy_assurance/Energy_Assurance_Plan-Texas.pdf

³⁴ <https://www.cisa.gov/sites/default/files/publications/nipp-ssp-chemical-2015-508.pdf>

operational and functional needs. The lifeline³⁵ sectors of communications, energy, transportation and water/wastewater are identified with red text. In addition to interdependencies between sectors, there are several interdependencies within sectors. One of the most important, however less understood relationships, is the need for electrical power to start electrical power generation. Accordingly, energy independence increases resilience.

SUPPORTED CRITICAL INFRASTRUCTURE SECTORS

	Chemical	Commercial Facilities	Comms	Critical Manufacturing	Dams	Defense Industrial Base	Emergency Services	Energy	Financial Services	Food and Agriculture	Govt Facilities	Healthcare	Information Technology	Nuclear	Transportation	Water and Wastewater
Chemical																
Commercial Facilities																
Comms																
Critical Manufacturing																
Dams																
Defense Industrial Base																
Emergency Services																
Energy																
Financial Services																
Food and Agriculture																
Govt Facilities																
Healthcare																
Information Technology																
Nuclear																
Transportation																
Water and Wastewater																

SUPPORTING CRITICAL INFRASTRUCTURE SECTORS

Table 3.3: Analysis of Sector Interdependencies³⁶

3.2.4 Supply Chain

As witnessed during the COVID-19 pandemic, the time it takes to recover from disasters depends heavily on the resiliency of the supply chain. When it comes to EMP events, a long-term regional power outage may stem from a variety of degraded or destroyed electrical components such as transformers, relays, breakers, switches, capacitors, control systems, etc. Figure 3.2 reflects a high-level representation of vulnerable grid components. Although each component relies on a unique supply chain, the transformer supply chain is covered in more detail as one example. Not only are

³⁵ <https://www.cisa.gov/sites/default/files/publications/Guide-Critical-Infrastructure-Security-Resilience-110819-508v2.pdf>

³⁶ <https://www.cisa.gov/2015-sector-specific-plans>

transformers challenging to repair, they are laborious to replace and there are few replacements available in inventory. Further, the majority of transformers are custom made and produced outside of the United States. The aftermath of an electromagnetic event would extend the transformer supply chain well beyond its capacity, and in the case of a GMD, manufacturing of new transformers would be severely hindered, if not completely destroyed.³⁷

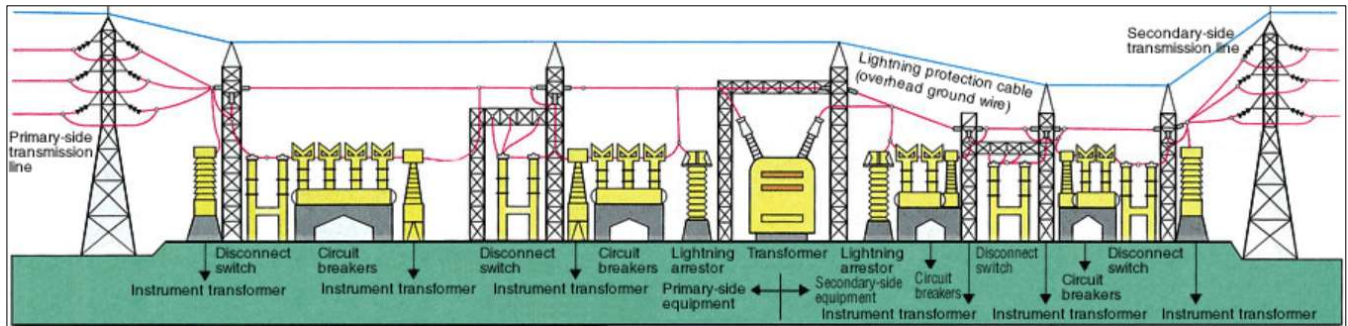

Figure 3.2: General Grid Components³⁸

Supply chain networks vary greatly depending on the enterprise, product, and region. Figure 3.3 illustrates a representation of a petroleum supply chain. Knowing the locations of key supply chain functions that serve our community and knowing the owners and operators of these functions are vital for building resiliency. Additionally, processes for transactions of money, information, and products within the supply chain should be factored into resiliency planning efforts.

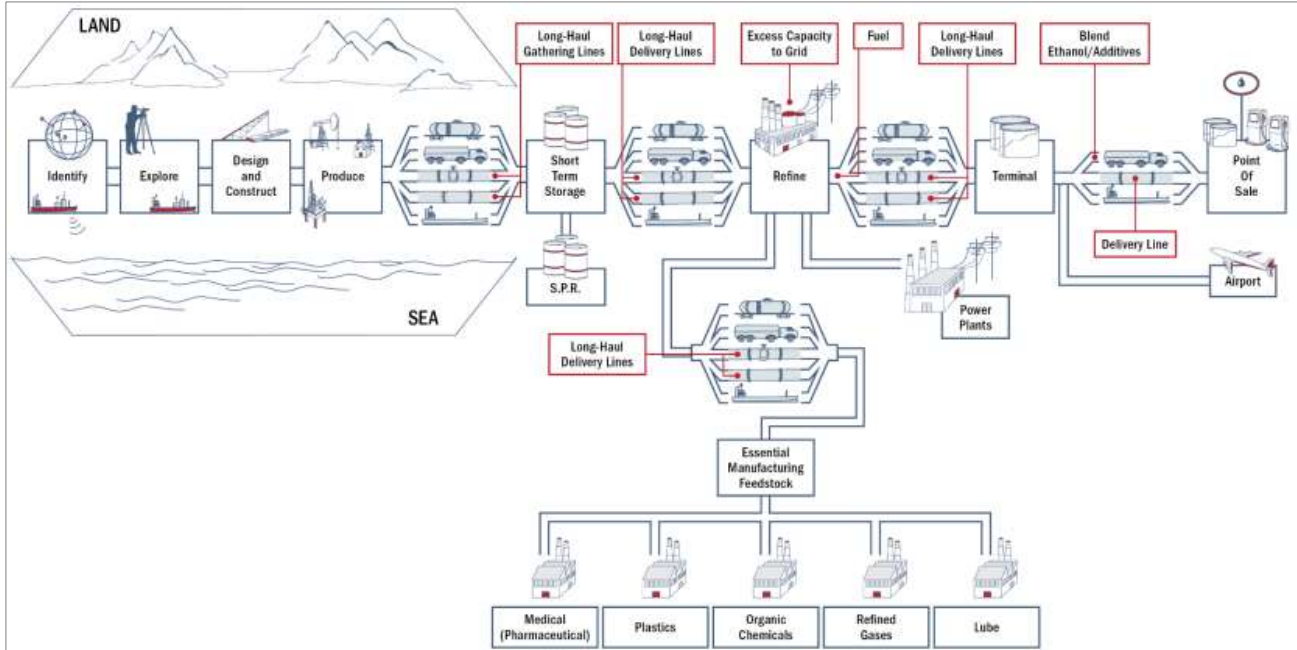

Figure 3.3: Petroleum Supply Chain Diagram³⁹

³⁷ https://www.energy.gov/sites/prod/files/Large%20Power%20Transformer%20Study%20-%20June%202012_0.pdf

³⁸ https://www.tepco.co.jp/en/corpinfo/ir/kojin/images/transformation_zoom01.gif

³⁹ <https://www.fema.gov/sites/default/files/2020-07/supply-chain-resilience-guide.pdf>

4. EMP Resiliency Maturity Model

The EMP Resiliency Maturity Model provides a framework to assess resiliency at each level maturity. It provides simple standards and objectives to which education and training should be developed. Each phase shown in Figure 4.1 has a simple assessment component to advance to the next level of maturity. Information defining each organizational level and mission area are detailed below.



Figure 4.1: Progression of Maturity Levels

The EMP Resiliency Maturity Model uses the National Preparedness System. The system describes ways to improve coordination between organizations to increase preparedness for disasters, thereby reducing the disruption they cause. The preparedness mission areas as outlined in section 3.1 of this guide are referenced as resiliency mission areas in the context of an EMP event. The five resiliency mission areas are: awareness, protection, mitigation, response, and recovery. The maturity model should be applied to the sixteen critical infrastructure sectors.

The National Preparedness System mission areas include “prevention;” however, in the context of SA-EMD DEMSO, the prevention mission area is not appropriate. According to the PPD-8, prevention is the only mission area that has activities focused solely on an imminent terrorist threat. Although prevention activities for HEMP exist, they are outside the purview of SA-EMD. However, it is worth noting that if local communities around the nation are resilient to and prepared for a man-made EMP, it supports a dissuasion strategy to deter adversarial use of EMP as a weapon.

Preparing for a long-term regional power outage is an activity that builds resilience to many disasters, including natural such as hurricanes, tornadoes, earthquakes, severe winter weather, as well as man-made such as cyber or terrorist attacks. As such, awareness of dependency on the electric grid, protection from, mitigation of, response to and recovery following a long-term regional power outage are all part of building resiliency.

As shown in Figure 4.2, the EMP Resiliency Maturity Model is depicted as a 3-dimensional cube with five organizational levels, across five mission areas, mapped against five maturity levels. The characteristics of the organizational levels, mission areas, and maturity levels are described in subsequent sections.

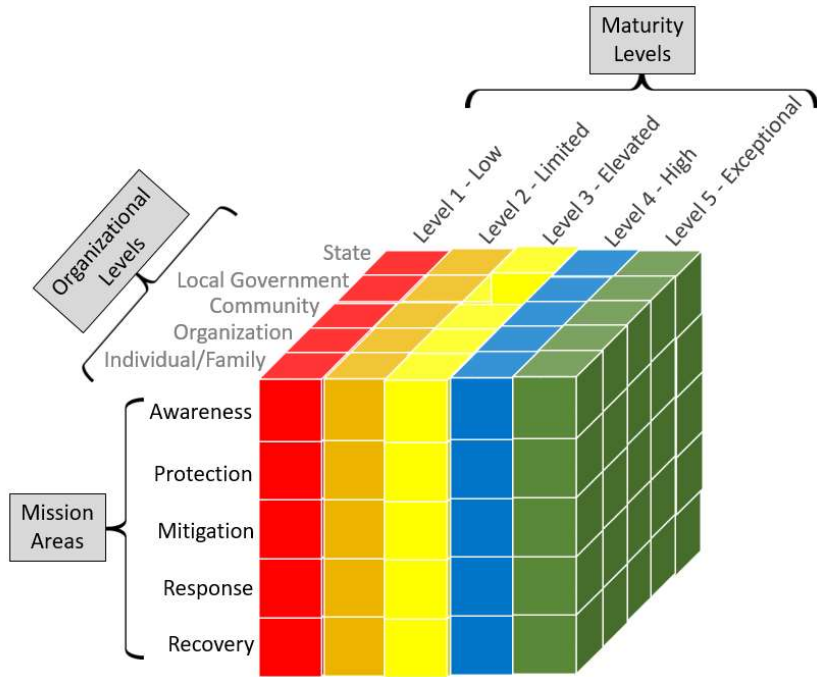

Figure 4.2: EMP/GMD Resiliency Maturity Model

4.1 Mission Areas

For San Antonio to prepare for EMP/GMD, critical infrastructure sectors will require tailored EMP/GMD resiliency countermeasures. Each critical infrastructure sector will require its own “maturity model cube.” This maturity model can be built with the critical infrastructure sector lead as the main content provider (e.g. the wastewater entity articulates the wastewater plan in the event of an extended power outage). Cross-sector planning is also important (e.g. the wastewater treatment plan may impact the water treatment plan). This construct provides a robust framework to EMP/GMD resilience.

For EMP events, effective action begins with identifying the threats and hazards and determining the associated vulnerabilities and consequences. This evaluation is dependent on a risk assessment that is based on scientific and technological information. A risk assessment should start with an evaluation of the impact of a power grid failure and the cascading impact on each of the remaining fifteen critical infrastructure sectors. For communities and local governments, tabletop exercises that walk through the response and recovery for a long-term power outage and involve local government, emergency management, and leaders from critical infrastructures are opportunities to build awareness, uncover vulnerabilities, and begin contingency planning. The InfraGard National Disaster Resiliency Council, formerly the EMP Special Interest Group has developed The Triple Threat Power Grid Exercises ⁴⁰ that offers three scenarios: a cyber-attack, a GMD, and an EMP

⁴⁰ C. Manto, G. Baker et al, “Triple Threat Power Grid Exercise: High Impact Threats Workshop and Tabletop Exercises Examining Extreme Space Weather, EMP and Cyber Attacks,” October 2015

event for this purpose. This is one example of many self-assessment tools available, which is scalable from individual families, up to cities and states.

Information sharing and warning systems are a critical aspect of planning. In general, it is possible to get an early warning of a natural GMD event but rarely possible to get an early warning of a man-made EMP event. NOAA and NASA monitors Coronal Mass Ejections (CME) and solar storms that could lead to GMD. Effective dissemination of warning information to the utilities and community could help prepare for an imminent GMD event. Early warning of GMD or EMP events allow utility companies to disconnect or shift to standby modes in order to protect against power surges. Early warning coupled with effective information dissemination, allows everyone to prepare for the event. Unfortunately, man-made EMP events may have little to no warning emphasizing the importance of preemptive countermeasures and robust recovery readiness.

4.1.1 Awareness

Awareness of the threat and impact of an EMP event is necessary to provide the motivation to build resiliency. Without awareness, there is no widespread motivation to act. The Awareness Levels on the EMP Resiliency Maturity Model are as follows:

- Level 1 - Low (unaware or misinformed)
- Level 2 - Limited (some awareness but no knowledge of effects)
- Level 3 - Elevated (basic awareness of cause and some effects)
- Level 4 - High (fully aware and knowledge of some possible effects)
- Level 5 - Exceptional (Fully aware of all possible effects, able to articulate and justify support actions for yourself and others)

Awareness at each level will look different for various organizations. Therefore, Awareness characteristics at each level; individual/family through state, will look different. The books “Powering Through”⁴¹ and the “Power Outage Incident Annex to the Response and Recovery Federal Operational Plans”⁴² offer examples of the threat and potential impacts of an EMP event at each level. Keep in mind that, public awareness campaigns have the potential to influence awareness at many levels simultaneously.

4.1.2 Protection

The role of protection is to guard against the effects of the hazard, reduce vulnerabilities or minimize the consequences of the hazard. Protection should address the threats from both HEMP and GMD. For HEMP, both the E1 and E3 pulses should be considered.

Examples of protection activities associated with an EMP event include:

- Assessing electric equipment (computers, servers, appliances, etc.) and main power lines that serve the building to determine vulnerabilities.

⁴¹ M. Lasky, W. Harris, et al, “Powering Through “From Fragile Infrastructures To Community Resilience,” January 2016

⁴² DHS, “Power Outage Incident Annex to the Response and Recovery Federal Interagency Operational Plans, Managing the Cascading Impacts from a Long-Term Power Outage,” June 2017

- Evaluating and procuring appropriate EMP-rated “protection” for equipment and main power fuse boxes
- Procuring faraday cages to protect electronic equipment
- Hardening electrical systems against EMPs

4.1.3 Mitigation

Mitigation is intended to minimize the risk associated with an EMP event, including cascading and unknown effects. Mitigation supports protection activities, thereby easing response and speeding recovery to create better prepared and more resilient communities. Redundancy is often a prudent mitigation strategy.

4.1.4 Response

The National Response Framework (NRF) defines response as, “actions necessary to save lives, protect property and environment, stabilize the incident, and meet basic human needs following an incident.”⁴³ Actions of incident response include the execution of emergency plans and tasks which enable recovery. The primary focus is to stabilize critical services that enable continuous operation of vital government/business functions and are crucial to health and safety of the population. Secondary considerations are given to economic factors and the natural and cultural environment. Although the number of organizations involved with disaster and emergency responses are based on the size and complexity of the incident, all responses require coordination, integration and unity of response across all organizations involved.

Initial response actions for a destructive GMD should begin with notification of an imminent threat potentially leading to shutdown/disconnection of the power grid until the last elements of the CME have passed. Since non-destructive GMD events happen regularly, disconnecting the power grid for anything less than severe solar storms would induce unnecessary disruption of society and potentially risk loss of life. For this reason, the authority to declare an Electric Power Emergency only lies at the highest levels of government and not with the power plant owners/operators.⁴⁴ Initial response actions for a HEMP are similar except the incident will have little to no-notice and the duration of the incident will be shorter.

4.1.5 Recovery

Resilience as defined by the National Preparedness Goal is “the ability to adapt to changing conditions and withstand and rapidly recover from disruption due to emergencies.” Recovery, however, is defined differently by each community. Based on circumstances, challenges, visions and priorities, one community may describe recovery as the economic return to pre-disaster conditions, while another may view success as beginning new economic ventures. Generally speaking, characteristics of resilient and sustainable recovery includes restoration of physical structures, continuity of services and support to meet the needs of affected community members experiencing physical, emotional, and/or financial hardships. Recovery should also reinforce

⁴³ https://www.fema.gov/sites/default/files/2020-04/NRF_FINALApproved_2011028.pdf

⁴⁴ https://www.energy.gov/sites/prod/files/2019/10/f67/Federal%20Power%20Act_2019_508_0.pdf

systems supporting economic stability, vitality, and long-term sustainability of the entire community.⁴⁵

The recovery process can be described as interdependent and simultaneous actions that propel a community toward planned recovery goals. Short- and long-term priorities are set by the community during pre-disaster planning and early in the recovery process. Figure 4.3 reflects the associations of recovery activities on a continuum. The figure emphasizes the fact that, preparedness, response and recovery activities are not and should not be isolated or only sequential.

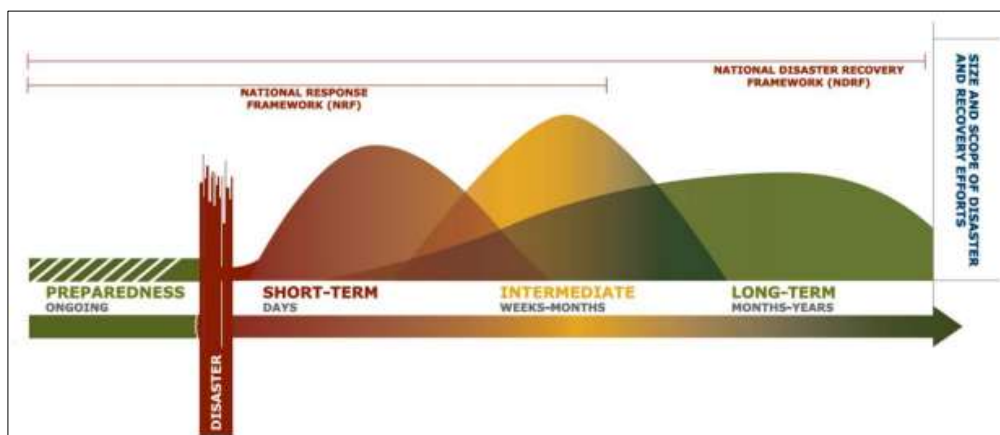

Figure 4.3: Recovery Flow⁴⁶

When conducting pre-disaster recovery planning for GMD events, plans will need to navigate around challenges such as power outages, and transformers being down, but smaller unplugged electronics working. On the other hand, recovery plans for HEMP will need to address power outages and significant damage to electronic equipment.

4.2 Organizational Levels

Coordination and feedback from each level of organization is vital to ensure effective preparedness planning. Policy from the highest levels inform plans and actions on the lowest levels. The five organizational levels covered within the EMP Resiliency Maturity Model are individual/family, organization, community, local government, and State.

4.2.1 Individual/Family

Individual preparedness is fundamental to the community success of the National Preparedness Goal. If individuals, particularly first responders and employees with emergency response functions, and their families are not prepared for an EMP event or long-term power outage, they will not be available to assist when the time comes. They will be busy taking care of their family's needs. The FEMA 2020 National Household Survey on Individual and Community Preparedness showed that, in general, the American's surveyed are trending toward higher levels of disaster

⁴⁵ https://www.fema.gov/sites/default/files/2020-06/national_disaster_recovery_framework_2nd.pdf

⁴⁶ https://www.fema.gov/sites/default/files/2020-06/national_disaster_recovery_framework_2nd.pdf

preparedness.⁴⁷ The major influencers to hazard preparedness were having read, seen or heard information about preparing for the disaster in the past six months (awareness), experience with disasters, believing that preparing can help in a disaster, and acknowledging that the disaster could impact where they live.

Awareness:

Individuals and families should be aware of the threat and the impact of an EMP event. It is the responsibility of the local emergency management office to provide the public with information on the threat and the possible impacts of an EMP event, including the possibility of a long-term power outage.

Protection:

- Shielding devices such as faraday cages can be used to protect electronic equipment

Mitigation:

Armed with the awareness of the possible impact of an EMP event and an understanding of vulnerabilities, families can develop a plan to mitigate the impact of an EMP/GMD event and the resulting long-term power outage. HEMP/GMD mitigation is similar to all-hazards mitigation at the individual/family level, except longer and with no Federal/State support. Supplemental EMP preparedness information for individuals can be found on the Ready.Gov page for Space Weather.⁴⁸ Plans should include preparing for the loss of services from all sixteen critical infrastructures, most notably the following critical lifeline functions:

- Power: Acquiring an alternate source of power that can serve your home (generator and fuel, renewable energy with battery storage, etc.)
- Communications: Determine how family members will contact each other following an EMP event. During and after the event, traditional communications, such as cell phone towers, will not be available.
- Food: During a long-term power outage, food distribution and commercial refrigeration will be impaired leading to food shortages. Families should acquire non-perishable food supplies that last at least two weeks and, ideally up to a year.
- Water/Wastewater: Municipal water systems will be impaired as lack of power will shut down their pumps and treatment chemicals become unavailable. Families should acquire food and water supplies that last at least two weeks and, ideally up to a year. For water, plan for 1 gallon per day for every person and pet in the family. A family of four would require 56 gallons of water for 2 weeks. For long-term needs, consideration should be given to ways of collecting and purifying water.
- Funds: During a long-term power outage, the financial sector will be compromised. Having cash or method of credit will be needed until financial services are restored.
- Medical/Health and Special needs: Plan to meet any medical special needs. For example, plan to have additional supplies of any medications you require or have a plan for acquiring them after an EMP event.

⁴⁷ <https://community.fema.gov/story/2020-NHS-Data-Digest-Summary-Results>

⁴⁸ <https://www.ready.gov/space-weather>

Individual/Family					
	Level 1 Low	Level 2 Limited	Level 3 Elevated	Level 4 High	Level 5 Exceptional
Awareness	Unaware or misinformed	Some awareness but no knowledge of effects	Basic awareness of cause and some effects	Fully aware & knowledge of some possible effects	Fully aware of all possible effects and why
Protection	No EMP/GMP protection	Inventory and assessment of electric appliances, computers and mobile devices	Some electronic devices and appliances protected with EMP-rated protection	Electronic devices and appliances protected with EMP-rated protection	Electronic appliances, devices, and main fuse box protected with EMP-rated protection
Mitigation	No plan for loss of services from critical infrastructure and particularly critical lifeline functions	Assessment of impact to loss of critical services, particularly the critical lifeline functions and drafting a mitigation plan	Established a mitigation plan for the loss of critical services, such as lifeline functions	Mitigation plan to reduce EMP/GMD event impact is implemented	Mitigation plan is tested and refined and integrated across other level of organization
Response	No response plan	Evaluating for and drafting a response plan	Established response plan but no drills	Response plan is exercised and lessons learned applied	Response plan integrated and exercised with plans from other levels of organization
Recovery	No recovery plan	Evaluating for and drafting a recovery plan	Established recovery plan but no drills	Recovery plan is exercised and lessons learned applied	Recovery plan integrated and exercised with plans from other levels of organization

Table 4.1: Characteristics of Individual/Family at each Maturity Level

4.2.2 Organization

Organizations have a formal structure with a specific mission. Maintaining operations in light of a disaster is of prime importance to continued success after the disaster. In addition, organizations usually rely on their “employees” to fulfill their business mission. Although organizations may not have control over their employees outside of work hours, ensuring that employees are prepared for a disaster is important for continued operations during a disaster. If employees are not prepared, they will likely be taking care of their immediate needs and less likely to be available to assist with the organization’s disaster response/recovery plan.

In order to mitigate the impact of EMP/GMD events, organizations must be aware of the specific vulnerabilities they have to EMP threats and resulting long-term power outages and include these scenarios in a Business/Operations Continuity Plan.⁴⁹ According to the Business Continuity Institute’s 2018 Horizon Scan Report,⁵⁰ the top 10 threats to business continuity are:

⁴⁹ <https://www.iso.org/standard/75106.html>

⁵⁰ <https://www.bsigroup.com/LocalFiles/en-GB/iso-22301/case-studies/BCI-Horizon-Scan-Report-2018-FINAL.pdf>

- Cyber-attack
- Data breach
- IT/telecom outages
- Interruption to utility supply
- Adverse weather
- Act of terrorism
- Security incident
- Fire
- Supply chain disruption
- Transport network disruption

Although majority of the threats listed have the potential to lead to power outages, none directly trigger planning for long-term regional impacts like EMP and GMD threats do. Still, an EMP event and the cascading effects involve five out of the ten threat scenarios listed.

Organization					
	Level 1 Low	Level 2 Limited	Level 3 Elevated	Level 4 High	Level 5 Exceptional
Awareness	Entity and employees are unaware or misinformed	Entity and employees have some awareness but no knowledge of effects	Entity and employees have basic awareness of cause and some effects	Entity and employees are fully aware and knowledge of some possible effects	Entity and employees are fully aware of all possible effects and why
Protection	Entity has no EMP/GMP protection	Inventory and assessment of electric appliances, computers and mobile devices	Some electronic devices and appliances protected with EMP-rated protection	Electronic devices and appliances protected with EMP-rated protection	Electronic appliances, devices, and main fuse box protected with EMP-rated protection
Mitigation	Continuity Plan does not cover EMP/GMD events	Evaluate and assess preparedness guidance and needs for business continuity	Conduct risk assessment of EMP/GMD event on business continuity	Exercise EMP/GMD preparedness checklist and apply lessons learned	Integrate and exercise preparedness actions with plans from other levels of organization
Response	Continuity Plan does not cover EMP/GMD events	Evaluate and assess response guidance and needs for continuity plan	Establish EMP/GMD response checklist for continuity plan	Exercise EMP/GMD response checklist and apply lessons learned	Integrate and exercise response checklist with plans from other levels of organization
Recovery	Continuity Plan does not cover EMP/GMD events	Evaluate and assess recovery guidance and needs for continuity plan	Establish EMP/GMD recovery checklist for continuity plan	Exercise EMP/GMD recovery checklist and apply lessons learned	Integrate and exercise recovery checklist with plans from other levels of organization

Table 4.2: Characteristics of Organization at each Maturity Level

4.2.3 Community

A community is described as a group of people living in the same general area or sharing a specific characteristic in common. Communities drive resiliency by forming informal communications and support systems. Over the past century, we have become less self-sufficient. For example, food production has become more industrialized allowing for less reliance on local foodstuffs. A lack of self-sufficiency makes us vulnerable to disruptions in the food supply chain. A concept that has

been gaining traction in recent years is the concept of resilient community islands. Resilient community islands ⁵¹ are communities that are made self-sufficient by having interlinked but independent resources like power, water, and food. A resilient community island may be connected to the municipal electric grid, but also have a microgrid that can be isolated if the municipal electric grid fails. By having localized resources, a community is less vulnerable to disruptions in centralized services. Resilient community islands can be formed by loosely organized groups like neighborhood or homeowner associations or more formal groups like universities systems or school districts. Important aspects of resilient community islands include:

- Power Supply: A microgrid that is EMP-protected for isolated, renewable, resilient power.
- Water supply: water storage tanks or cisterns for water collection
- A Focal point for communications, food distribution, socialization, etc.
- Basic medical supplies
- Basic security or protection such as a Neighborhood Watch
- Food source from community gardens or food reserves

Community					
	Level 1 Low	Level 2 Limited	Level 3 Elevated	Level 4 High	Level 5 Exceptional
Awareness	Unaware or misinformed	Some awareness but no knowledge of effects	Basic awareness of cause and some effects	Fully aware and knowledge of some possible effects	Fully aware of all possible effects and why
Protection	No EMP/GMD Protection	Inventory and assessment of EMP/GMD vulnerabilities in community	Plan to procure proper EMP/GMD protection	Install EMP-rated protection as feasible	EMP-protected resilient community island
Mitigation	Community is not organized around resiliency	Community has mechanism for communication and starting to talk about food, water and power resiliency	Group maintains communications, shares a combined garden, pantry, water supply and evaluates feasibility of microgrid	Community has all the elements of level 3 plus has a resilient microgrid	Community is an EMP-protected, resilient community island
Response	No response plan	Evaluating for and drafting a response plan	Established response plan but no drills	Response plan is exercised and lessons learned applied	Response plan integrated and exercised with plans from other levels of organization
Recovery	No recovery plan	Evaluating for and drafting a recovery plan	Established recovery plan but no drills	Recovery plan is exercised and lessons learned applied	Recovery plan integrated and exercised with plans from other levels of organization

Table 4.3: Characteristics of Community at each Maturity Level

⁵¹ M. Lasky, W. Harris, et al, “Powering Through: Building Critical Infrastructure Resilience,” pg 89 January 2021

4.2.4 Local Government

Community resilience and preparedness for a disaster is best led by the local government. They are responsible for bringing together the community leaders, and evaluating the risks and vulnerabilities, communicating with their citizens, and developing a comprehensive and appropriate response and recovery plan. FEMA has guides for protection, mitigation, response, and recovery planning that are written specifically to support local government through the process. Other sources such as *Powering Through: From Fragile Infrastructure to Community Resilience* and *Powering Through: Building Infrastructure Resilience*, provide guidance specifically for evaluating and planning for an EMP event. Local governments can also determine where to invest for mitigation activities and protection of the power grid and other critical infrastructure assets.

Local Government					
	Level 1 Low	Level 2 Limited	Level 3 Elevated	Level 4 High	Level 5 Exceptional
Awareness	Unaware or misinformed	Some awareness but no knowledge of effects	Basic awareness of cause and some effects	Fully aware and knowledge of some possible effects	Fully aware of all possible effects and why
Protection	Critical infrastructure is not EMP/GMD protected	Risk and vulnerability assessment of EMP-event impact on critical infrastructure	Electric Grid and Water systems are protected with EMP-rated protection	Electric grid, water, communications and medical facilities are protected with EMP-rated protection	All critical infrastructures are protected from EMP
Mitigation	Local government is not prepared for an EMP/GMD event or long-term power outage	Local Government forms an EMP/GMD Steering Committee to evaluate the impacts of EMP/GMD at their level	EMP Steering Committee and leaders participate in long-term power outage table-top exercise	EMP Steering Committee drafts a mitigation plan based on the results of the table-top exercise	Approved EMP Mitigation plan and regular long-term power outage exercises conducted and plan refined
Response	No response plan	Evaluating for and drafting a response plan	Established response plan but no drills	Response plan is exercised and lessons learned applied	Response plan integrated and exercised with plans from other levels of organization
Recovery	No recovery plan	Evaluating for and drafting a recovery plan	Established recovery plan but no drills	Recovery plan is exercised and lessons learned applied	Recovery plan integrated and exercised with plans from other levels of organization

Table 4.4: Characteristics of Local Government at each Maturity Level

4.2.5 State Government

States are all very different in their regulations governing utilities and power over individual cities and communities. They are also different in their vulnerabilities to various disasters. As such, there is not a one-size fits all solution to EMP resiliency plan. However, there are a few states that have walked the path and can discuss their process and lessons learned.

In 2019, the Wyoming Office of Homeland Security released their Power Outage Annex. Leadership in Wyoming understood that a catastrophic power outage would pose a significant danger to lives. They anticipated, in such an event, it may take days to weeks to restore limited power and months to years to return to pre-disaster service. The goal of this project was to mitigate the effects of grid failure caused by EMP but also other hazards (cybersecurity, physical damage, etc.) by restoring power as quickly as possible and conducting lifesaving and life-sustaining activities. Wyoming had four Long-Term Power Outage Priorities:

1. Protect the Grid
2. Reconstitute the Grid
3. Consequence Management: responding to and mitigating the damage from a long-term power outage. Especially the cascading effects of Long-Term Regional Power Outage (LTRPO) on critical sectors and community lifelines (safety, security, food, water, shelter, health/medical, energy, communications and transportation)
4. Continuity of Government

Wyoming, like many other states, has challenges presented by the distributed nature of their power generation and power distribution systems. Wyoming has five major power generators and numerous power distributors with different for profit or non-profit business models. To add to the complexity, many of these utilities are governed by different regulatory authorities. Only some of these utility companies are regulated by the Wyoming Public Service Commission. These challenges directly affected the states' ability to control the first two priorities, to protect and reconstitute the grid. As such, Wyoming's approach stresses response and recovery from a long-term power outage with a planning assumption that initial and limited power can be restored within 90 days.

In Wyoming, a Grid Steering Committee was formed to coordinate the state effort. The Grid Steering Committee included the Director of the Wyoming Office of Homeland Security, The Adjutant General of Wyoming, the Chairman of the Public Service Commission, and Policy Advisor from the Governor's Staff. The Grid Steering Committee was tasked with developing a plan to prevent, respond to, and mitigate the effects of a long-term power outage, as well as operational coordination. They conducted a risk and vulnerability assessment to inform their plan development.

State Government					
	Level 1 Low	Level 2 Limited	Level 3 Elevated	Level 4 High	Level 5 Exceptional
Awareness	Unaware or misinformed	Some awareness but no knowledge of effects	Basic awareness of cause and some effects	Fully aware and knowledge of some possible effects	Fully aware of all possible effects and why
Protection	Critical infrastructure is not EMP/GMD protected	Risk and vulnerability assessment of EMP-event impact on critical infrastructure	Electric Grid and Water systems are protected with EMP-rated protection	Electric grid, water, communications and medical facilities are protected with EMP-rated protection	All critical infrastructures are protected with EMP
Mitigation	State government is not prepared for an EMP/GMD event or long-term power outage	State Government forms an EMP/GMD Steering Committee to evaluate the impact of EMP/GMD at their level	EMP Steering Committee and leaders participate in long-term power outage table-top exercise	EMP Steering Committee drafts a mitigation plan based on the results of the table-top exercise	Approved EMP Mitigation plan and regular long-term power outage exercises conducted
Response	No response plan	Evaluating for and drafting a response plan	Established response plan but no drills	Response plan is exercised and lessons learned applied	Response plan integrated and exercised with plans from other levels of organization
Recovery	No recovery plan	Evaluating for and drafting a recovery plan	Established recovery plan but no drills	Recovery plan is exercised and lessons learned applied	Recovery plan integrated and exercised with plans from other levels of organization

Table 4.5: Characteristics of State Government at each Maturity Level

5. EMP Resiliency Education

This section is written for leaders that are responsible for the health and well-being of their command, employees, citizens and/or family. The purpose of this section is to help build EMP/GMD organizational resilience.

5.1 Elements of EM Resiliency Education Curriculums

DEMSO education curricula should be layered to meet the needs of each level in society: Individual/Family to Government. At the minimum, curriculum should address each of the mission areas: awareness, protection, mitigation, response, recovery. Unfortunately, there are not many Electromagnetic Resilience educational tools currently available. As such, below are descriptions of educational tools that are available and strategies for creating educational tools to fill current gaps.

5.1.1 Public Service Campaigns

A well-conceived public service campaign has the potential to raise awareness and provide basic protection, mitigation, response, and recovery information to the entire area which can influence all levels of society. The following are communication channels that may be utilized to support public service campaigns⁵²:

- Web Pages
- Social Media
- Web-enabled Training
- Public Media
- Executive Briefings
- Technical presentations
- Exhibits at conferences
- Seminars tailored to different audiences
- Trade Publications
- Electronic News Organizations
- Press Releases
- Special Event

5.1.2 Individual/Family

- Education program for children where information is discussed with family
 - o Kindergarten – 5th grade:
 - “Smokey the Bear” – type of Public Service Campaign for basic awareness and preparedness/mitigation information.
 - o 6th-8th grade:
 - “Oregon Trail”-type interactive game to gamify the impact, preparedness, and mitigation of an EMP/GMD Event
 - “Catastrophe” – A resilience game that promotes collaboration to ensure group survival while utilizing limited resources. Free virtual play is available today, and physical boxed sets are available for purchase.⁵³
 - o 9th-12th grade:
 - Incorporate EMP/GMD topics into the science Texas Education Agency Texas Education Knowledge and Skills (TEA-TEKS) curriculum (Integrated Science and Physics)
 - o PTA/PTO organized disaster resiliency events
- Ready.gov materials on Space Weather/Solar storms and All-Hazards preparedness.

5.1.3 Organizations

- Awareness presentations to organization leaders
- Specialized training programs designed to meet the needs of different critical infrastructure sectors (like current cybersecurity programs)
- Conduct tabletop exercises to test and assess preparedness, response and recovery

5.1.4 Community

- Presentations to homeowner associations, PTAs, etc. for EMP/GMD awareness, protection, mitigation, response, recovery
- Presentations on building resilient community islands, etc.

⁵² <https://www.cisa.gov/sites/default/files/publications/Guide-Critical-Infrastructure-Security-Resilience-110819-508v2.pdf>

⁵³ <https://tabletopia.com/games/catastrophe-game>

5.1.5 Local Government

- Awareness presentations for Government Leaders
- Conduct tabletop exercises to test and assess preparedness, response and recovery

5.1.6 Additional Education

Below are topics that may be considered for curriculum to understand San Antonio's response to EMP and GMD events and recognize sector inter-dependencies and cascading effects.

- EMP and GMD Threat
- Military Roles, Authorities and Responsibilities for EMP and GMD in SA
- Civilian Roles, Authorities and Responsibilities for EMP and GMD in SA
- SA Civ/Mil Planning for EMP and GMD
- SA Organization for EMP/GMD Response
- SA Security Response
- SA Critical Infrastructure Responses by Sector:
 - Chemical
 - Commercial Facilities
 - Communications
 - Critical Manufacturing
 - Dams
 - Defense Industrial Base
 - Emergency Services
 - Energy
 - Financial Services
 - Food and Agriculture
 - Government Facilities
 - Healthcare and Public Health
 - Information Technology
 - Nuclear Reactors Materials, and Waste
 - Transportation Systems
 - Water and Wastewater Systems

5.1.7 Recommended Reading

Listed below, in no specific order, are primary recommended reading documents to provide additional background and context to the EMP/GMD threat and resiliency building activities associated with the threats.

- (1) M. Lasky, W. Harris, et al, "Powering Through: From Fragile Infrastructures to Community Resilience," January 2016
- (2) M. Lasky, W. Harris, et al, "Powering Through: Building Critical Infrastructure Resilience," January 2021
- (3) D. Stuckenberg, R. J. Woolsey and D. DeMaio, "Electromagnetic Defense Task Force (EDTF) 2018 Report," LeMay Center for Doctrine Development and Education, Montgomery, 2018,
https://www.airuniversity.af.edu/Portals/10/AUPress/Papers/LP_0002_DeMaio_Electromagnetic_Defense_Task_Force.pdf
- (4) D. Stuckenberg, R. J. Woolsey and D. DeMaio, "Electromagnetic Defense Task Force (EDTF) 2.0 2019 Report," LeMay Center for Doctrine Development and Education, Montgomery, 2019,
https://www.airuniversity.af.edu/Portals/10/AUPress/Papers/LP_0004_ELECTROMAGNETIC_DEFENSE_TASK_FORCE_2_2019.PDF

- (5) EPA, “Power Resilience: Guide for Water and Wastewater Utilities,” June 2019, <https://www.epa.gov/sites/default/files/2016-03/documents/160212-powerresiliencguide508.pdf>
- (6) DHS, “Supply Chain Resilience Guide,” April 2019, <https://www.fema.gov/sites/default/files/2020-07/supply-chain-resilience-guide.pdf>

6. Conclusions

While the topic of catastrophic infrastructure collapse due to EMP or GMD can seem overwhelming, this document provides a path to segment that problem into workable steps. The reader is reminded to review the maturity model tables presented in Section 4 and take advantage of how they can facilitate planning and preparation. Just as centrally planned economies have failed in history, issues as complex as this must be dealt with at the organizational and household levels, and within a larger framework that facilitates synergy between the participants. Ultimately, responsibility for readiness must occur within each household and organization, it is not feasible to expect a perfect top-down mandated governmental solution. We must own this issue within the reaches of our individual spheres of authority.

Gaps in policy at several levels hinder support for rapidly building resiliency to electromagnetic threats. For example, the National Preparedness Framework does not identify a National Planning Scenario related to EMP, GMD, or long-term regional power outages. In addition, Sector Specific Plans are outdated, and Infrastructure Data Taxonomy does not align with current sectors.

Through targeted efforts, planners can navigate around numerous challenges to build resiliency from the personal, organizational, and community levels. Examples include;

- (1) prioritize resiliency efforts on infrastructure with the highest criticality
- (2) implement resiliency policies from the lowest level to counter complicated regulatory environments within critical infrastructure sectors
- (3) prioritize energy independence to reduce the impacts of cascading effects due to sector interdependencies
- (4) build familiarity with the locations, owners and operators of key supply chain functions in the local area and establish plans for processing transactions of money, information, and products to compensate for problematic supply chains

In support of Executive Order 13865, Joint Base San Antonio prioritized building EMP resiliency and formed the San Antonio Electromagnetic Defense (SA-EMD) collaborative to ensure the continuation of operations in a post-EMP environment. As the third line of effort within SA-EMD, DEMSO efforts and the development of this Resiliency Guide are critical to informing senior leaders across the community in the first of a two-phase approach. This guide completes phase one. Phase two will include more detail and lessons learned from JBSA and SA-EMD. Both efforts may be shared with military/civilian communities around the nation to assist with building community resilience, which enables mission assurance.

7. Recommendations

The National Incident Management System (NIMS) defines preparedness as “a continuous cycle of planning, organizing, training, equipping, exercising, evaluating, and taking corrective action in an effort to ensure effective coordination during incident response.” In addition to recommendations made throughout the guide, listed below in Table 7.1 are 15 proposed actions for organizations to execute in pursuit of EMP/GMD resilience aligned with the relevant guide section(s). Recommendations coincide with the preparedness cycle to offer resiliency efforts that can be made today, for little to no additional cost, within existing processes and programs. Although they are focused on San Antonio, much can be applied to other communities directly or by example. Additionally, recommendations shall not be construed to conflict with any state or federal statute or with any military or naval order, rule or regulation.

Plan		
1	Develop an EMP, GMD, or long-term regional power outage annex or checklist as a part of Continuity of Operations Plan	4.2
2	Implement a “communications out” plan (recall & operations process with prioritization of mission essential employees)	4.2
3	Establish family care plans for mission essential employees	4.2.1
4	Develop a generator and vehicle maintenance, operation, and fueling plan	4.1.4
5	Design plans for all functions which you depend on (example: water sector should plan for chemical requirements)	3.2.3, 4.2
6	Identify procedures for security, badging and access requirements	4.2.2, 4.2.3, 4.2.4, 4.2.5
7	Ensure a plan is in place for processing payroll, invoices, payments and receipts	4.2.2, 4.2.3, 4.2.4, 4.2.5
Organize & Equip		
8	Routinely engage with information sharing communities to build awareness and enable risk-informed, decision-making regarding hazards, threats, vulnerabilities, and consequences as they continue to evolve. ⁵⁴ Examples include: <ul style="list-style-type: none"> - Space Weather Prediction Center (SWPC) - Information Sharing and Analysis Centers (ISAC) - Protected Critical Infrastructure Information (PCII) - National Disaster Resilience Council (NDRC) - Alamo Area Council of Government’s (AACOG) Regional Emergency Preparedness Advisory Committee (REPAC) 	3.2, 4.1

⁵⁴ DHS, “Critical Infrastructure Threat Information Sharing Framework: A Reference Guide for the Critical Infrastructure Community”, October 2016, <https://www.cisa.gov/sites/default/files/publications/ci-threat-information-sharing-framework-508.pdf>

	- San Antonio Office of Emergency Management's (SAOEM) Emergency Management Coordination and Information Sharing (EMCIS) Committee	
9	Take advantage of funding opportunities such as: Building Resilient Infrastructure & Communities (BRIC) ⁵⁵ , Hazard Mitigation Grant Program (HMGP) ⁵⁶ , Emergency Management Performance Grant (EMPG) ⁵⁷ , State Homeland Security Program (SHSP) ⁵⁸ , Regional Catastrophic Preparedness Grants Program (RCPGP) ⁵⁹ , Continuing Training Grant (CTG), Defense Economic Adjustment Assistance Grant (DEAAG) ⁶⁰	3.2, 4.1
10	Integrate resilience into buildings as a part of planning, construction, and post-event rebuild (e.g., burying power lines underground) ⁶¹	4.1.3
Train		
11	Build a foundation of understanding and awareness by reviewing recommended documents and videos	5.1.7, 8
12	Attend relevant courses through: Critical Infrastructure Security and Resilience Training Portal found on the Homeland Security Information Network for Critical Infrastructure (HSIN-CI), Center for Domestic Preparedness (CDP) ⁶² , FEMA Independent Study Courses ⁶³ , FEMA in-person/online courses ⁶⁴ , National Training and Education Division (NTED) ⁶⁵ - Recommended Topics: critical infrastructure protection/security, continuity of operations, community lifelines, public-private partnerships, logistics and supply chain resilience, community resilience, disaster management, disaster preparedness	5.1
Exercise		
13	Observe, participate in and conduct EMP, GMD, and long-term regional power outage exercises: EARTHEx (EIS Council) ⁶⁶ , GRIDEx (NERC) ⁶⁷ , Triple Threat Power Grid Exercise (InfraGard) ⁶⁸ , Community-Based Water Resiliency Workshop (EPA) ⁶⁹	4.1, 5.1.3, 5.1.5
Evaluate & Improve		

⁵⁵ <https://www.fema.gov/grants/mitigation/building-resilient-infrastructure-communities>

⁵⁶ <https://www.fema.gov/grants/mitigation/hazard-mitigation>

⁵⁷ <https://www.fema.gov/grants/preparedness/emergency-management-performance>

⁵⁸ <https://www.fema.gov/grants/preparedness/homeland-security>

⁵⁹ <https://www.fema.gov/grants/preparedness/regional-catastrophic>

⁶⁰ <https://gov.texas.gov/organization/military/grants>

⁶¹ <https://info.ornl.gov/sites/publications/Files/Pub133097.pdf>

⁶² <https://cdp.dhs.gov/training>

⁶³ <https://training.fema.gov/is/crslist.aspx>

⁶⁴ <https://training.fema.gov/emcourses/schedules.aspx>

⁶⁵ <https://www.firstrespondertraining.gov/frts/npccatalog>

⁶⁶ <https://eiscouncil.org/earth-ex/>

⁶⁷ <https://www.nerc.com/pa/CI/ESISAC/Pages/GridEx.aspx>

⁶⁸ C. Manto, G. Baker et al, "Triple Threat Power Grid Exercise: High Impact Threats Workshop and Tabletop Exercises Examining Extreme Space Weather, EMP and Cyber Attacks," October 2015

⁶⁹ <https://www.epa.gov/communitywaterresilience/community-based-water-resiliency-training>

14	Data Analysis: Ensure inputs from all stakeholders are included to produce data synthesis, event reconstruction, trend analysis and root cause analysis	4.1, 5.1.3, 5.1.5
15	Improvement Planning: Ensure corrective actions are developed to be <u>S</u> pecific, <u>M</u> easurable, <u>A</u> chievable, <u>R</u> elevant and <u>T</u> ime-bound (SMART), address threats and priorities, and engage senior leaders to ensure their intent is achieved	4.1, 5.1.3, 5.1.4, 5.1.5

Table 7.1: EMP/GMD Resilience Recommendations

8. Other Relevant Documents

1. Dr. William Graham, "Chairman's Report: Commission to Assess the Threat to the United States from Electromagnetic Pulse (EMP) Attack", July 2017.
2. "U.S. Department of Energy Electromagnetic Pulse Resilience Action Plan", Department of Energy (DOE), January 2017.
3. "Electromagnetic Pulse (EMP) Protection and Resilience Guidelines for Critical Infrastructure and Equipment", National Coordinating Center for Communications (NCC), 5 February 2019.
4. "Strategic Primer: Electromagnetic Threats", Winter, 2018, Volume 4, The American Foreign Policy Council (AFPC).
5. C. E. Baum, "Reminiscences of High-Power Electromagnetics (Invited Paper)," *IEEE TRANSACTIONS ON ELECTROMAGNETIC COMPATIBILITY*, vol. 49, no. 2, pp. 211-218, May 2007.
6. W. J. K. a. R. Latter, "Electromagnetic radiation from a nuclear Explosion in Space," *Physics Review*, vol. 126, no. 6, pp. 1919-1926, June 1962.
7. P. Huard, "The first time the US tested an EMP weapon was a doozy," *wearethemighty.com*, 8 11 2016.
8. D. W. R. Graham, "Chairman's Report to Assess the Threat to the United States from Electromagnetic Pulse (EMP) Attack," Commission to Assess the Threat to the United States from Electromagnetic Pulse (EMP) Attack, Washington D.C., 2017.
9. U.S. Congress, *Public Law 106-398; 114 Stat. 1654A-345, Title XIV of the Floyd D. Spence National Defense Authorization Act of 2001*, Washington D.C., 2001.
10. Commission to Assess the Threat to the United States from Electromagnetic Pulse (EMP) Attack, "(Charter)," Commission to Assess the Threat to the United States from Electromagnetic Pulse (EMP) Attack, 2017.
11. T. Philips, Severe Space Weather—Social and Economic Impacts, Extended Summary Workshop Report, Washington D.C.: The National Academies Press, 2009.
12. G. B. White, The Community Cyber Security Maturity Model in Proceedings of the 40th Hawaii International Conference on System Sciences, 2007.
13. G. White and N. Sjelín, "The community Cyber Security Maturity Model," in *Cyber-Physical Security: Protecting Critical Infrastructure at the State and Local Level*, R. M. Clark and S. Hakim, Eds., Springer International Publishing AG, 2017.
14. G. B. White, "The Community Cyber Security Maturity Model," in *2011 IEEE International Conference: Technologies for Homeland Security*, Waltham, MA, USA, 2011.
15. G. White, The Community Cyber Security Maturity Model (CCSMM) Pre-Publication Manuscript, Unselected Publisher, (2020).
16. Federal Emergency Management Agency (FEMA), "<https://www.cisa.gov/national-critical-functions>," Federal Emergency Management Agency (FEMA), 2011.
17. Cyber Infrastructure Security Agency, "National Critical Functions," Cyber Infrastructure Security Agency, 2019. (Online). Available: <https://www.cisa.gov/national-critical-functions>. (Accessed 25 JAN 2020).
18. *IEEE Transactions on Antennas and Propagation*, vol. 26, no. 1, 1 1978
19. Terry C. Chapman Capt. USAF - Thesis - A computer Code for High Altitude EMP – January 1974 – ADA 777841

20. Louis W. Seiler, Jr. Capt. USAF – Thesis – A Calculation Model for High Altitude EMP – March 1975 -ADA 009208
21. <https://www.dhs.gov/xlibrary/assets/niac/niac-a-framework-for-establishing-critical-infrastructure-resilience-goals-2010-10-19.pdf>
22. https://www.rand.org/pubs/research_reports/RR2970.html
23. "Electromagnetic Pulse Analysis of a Small-town Power System AD A023927" by the Air Force Weapons laboratory - Kirtland AF base New Mexico - March of 1976
24. "Final Report of the Defense Science Board Task Force on Nuclear Weapons Effects National Enterprise", June 2010

9. Glossary of Acronyms and Abbreviations

5G	Fifth Generation Cellular Network Technology
AACOG	Alamo Area Council of Governments
ADP	Army Doctrine Publication
AFDP	Air Force Doctrine Publication
AFI	Air Force Instruction
AWWA	American Water Works Association
BATFE	Bureau of Alcohol, Tobacco, Firearms and Explosives
BRIC	Building Resilient Infrastructure and Communities
CBRN	Chemical, Biological, Radiological, and Nuclear
CDP	Center for Domestic Preparedness
CISA	Cybersecurity and Infrastructure Security Agency
CJCSI	Chairman of the Joint Chiefs of Staff Instruction
CME	Coronal Mass Ejection
CoSA	City of San Antonio
COVID	Coronavirus Disease
CPS	City Public Service Energy
CTG	Continuing Training Grant
DEMSO	Domestic Electromagnetic Spectrum Operations
DHHS	Department of Health and Human Services
DHS	Department of Homeland Security
DOC	Department of Commerce
DoD	Department of Defense
DOE	Department of Energy
DOJ	Department of Justice
DOS	Department of State
DOT	Department of Transportation
DPS	Department of Public Safety
DSCA	Defense Support Civil Authorities
EARTHEX	Emergency All-sector Response Transnational Hazard Exercise
EDI	Electromagnetic Defense Initiative
EMAC	Emergency Management Assistance Compact
EMC	Emergency Management Coordinator
EMP	Electromagnetic Pulse
E1	The component of EMP that is high amplitude and short duration
E2	The component of EMP that shares similarities with lightning strikes
E3	The component of EMP that is low amplitude and high duration
EMS	Electromagnetic Spectrum
EMSO	Electromagnetic Spectrum Operations
EMSSS	Electromagnetic Spectrum Superiority Strategy
EO	Executive Order
EPA	Environmental Protection Agency
EPRI	Electric Power Research Institute
ESC	Education Service Center

ESF	Emergency Support Function
FEMA	Federal Emergency Management Agency
FERC	Federal Energy Regulatory Commission
GIC	Geomagnetically Induced Currents
GMD	Geomagnetic Disturbance
GPA	Government and Public Affairs
GSA	General Services Administration
HEMP	High-Altitude Electromagnetic Pulse
HMGP	Hazard Mitigation Grant Program
HSEEP	Homeland Security Exercise and Evaluation Program
ISR	Intelligence, Surveillance, and Reconnaissance
JBSA	Joint Base San Antonio
JP	Joint Publication
JTEC	Joint Training and Experimentation Center
LTRPO	Long-Term Regional Power Outage
MA	Mission Assurance
MOU	Memorandum of Understanding
MT	Magnetotelluric
MTTP	Multi-Service Tactics, Techniques, and Procedures
NDRC	National Disaster Resilience Council
NERC	North American Electric Reliability Corporation
NIMS	National Incident Management System
NIPP	National Infrastructure Protection Plan
NRF	National Response Framework
NSCC	National Security Collaboration Center
PPD	Presidential Policy Directive
PUC	Public Utility Commission
PWD	City of San Antonio Public Works Department
SA-EMD	San Antonio Electromagnetic Defense
SAMHD	San Antonio Metropolitan Health Department
SAOEM	San Antonio Office of Emergency Management
SAWS	San Antonio Water System
SHSP	State Homeland Security Program
SSA	Sector Specific Agency
SSP	Sector Specific Plan
SwRI	Southwest Research Institute
TDEM	Texas Division of Emergency Management
TX A&M	Texas Agricultural and Mechanical University
USACE	United States Army Corps of Engineers
USAF	United States Air Force
USC	United States Code
USDA	United States Department of Agriculture
UTSA	University of Texas at San Antonio
VOAD	Volunteer Organizations Active in Disaster

Appendix – A: Doctrine Overview

Acknowledging the EMP threat, JBSA is leveraging its authority and responsibility to confront it. As the largest government agency in San Antonio, JBSA exercises its authority through orders and directives to establish policy which is guided by doctrine.

Elements of SA-EMD’s DEMSO overlaps with elements of DoD’s approach to Electromagnetic Spectrum Operations (EMSO). EMSO unifies electromagnetic warfare (EW) and spectrum management activities to support core national security objectives. Doctrine related to SA-EMD’s DEMSO efforts are listed below and grouped into the categories of: Civil; Homeland Security; Fundamentals; Mission Assurance; Planning; Chemical, Biological, Radiological, and Nuclear (CBRN); Intelligence; and Electromagnetic Spectrum Operations (EMSO). An overwhelming majority of military doctrinal publications are also publicly available online.

Civil:

HSPD 5, Management of Domestic Incidents: Establishes the National Incident Management System (NIMS).⁷⁰

FEMA Strategic Plan: “Creates a shared vision for the field of emergency management and sets an ambitious, yet achievable, path forward to unify and further professionalize emergency management across the country.”⁷¹

FEMA Mission Areas and Core Capabilities: Breaks down the 5 mission areas and identifies 32 core capabilities that support the mission areas.⁷²

National Response Framework, Catastrophic Incident Annex (NRF-CIA): Describes doctrine that applies to catastrophic incidents similar to an EMP/GMD incident.⁷³

Homeland Security Exercise and Evaluation Program (HSEEP): Provides set of fundamental principles for exercise programs, as well as a common approach to program management, design and development, conduct, evaluation, and improvement planning.⁷⁴

Homeland Security:

JP 3-27, Homeland Defense (HD): Provides military doctrine for the defense of the Homeland which overlaps with DEMSO.⁷⁵

JP 3-28, Defense Support of Civil Authorities (DSCA): Provides description of DoD support to civilians which is an element of DEMSO. One key aspect is as follows: “State and local officials are responsible for preparing for and coordinating the provision of assistance to their populace for domestic emergencies and disasters. When an incident occurs that exceeds or is anticipated to exceed state, local, or tribal resources, both neighboring states and the US Government may provide

⁷⁰ <https://www.dhs.gov/sites/default/files/publications/Homeland%20Security%20Presidential%20Directive%205.pdf>

⁷¹ https://www.fema.gov/sites/default/files/2020-03/fema-strategic-plan_2018-2022.pdf

⁷² <https://www.fema.gov/emergency-managers/national-preparedness/mission-core-capabilities>

⁷³ https://www.fema.gov/pdf/emergency/nrf/nrf_CatastrophicIncidentAnnex.pdf

⁷⁴ <https://www.fema.gov/sites/default/files/2020-04/Homeland-Security-Exercise-and-Evaluation-Program-Doctrine-2020-Revision-2-2-25.pdf>

⁷⁵ Joint Pub 3-27 Homeland Defense. P GL-8. https://www.jcs.mil/Portals/36/Documents/Doctrine/pubs/jp3_27.pdf

resources and capabilities to support the response.”⁷⁶

JTEC, DSCA Handbook: Assists Commanders with planning DSCA.

AFDP 3-27, Homeland Operations: Describes the construct under which many aspects of DEMSO fall. The Air Force includes Emergency Preparedness (EP) within the homeland operations umbrella as an integral subset mission of both HD and DSCA. EP is defined as “the measures taken in advance of an emergency to reduce the loss of life and property, and to protect a nation’s institutions from all types of hazards through a comprehensive emergency management program of preparedness, mitigation, response and recovery.”⁷⁷

Fundamentals:

Air Force Primer on Doctrine: Describes the Air Force view (purpose, uses, etc.) on all Air Force doctrine.⁷⁸

CJCSI 5120.02 Joint Doctrine Development System: Describes Joint policy for developing doctrine.⁷⁹

DoD Dictionary: Provides definitions of terms for the armed forces. New terms may be created and defined for advancement of DEMSO, however, new terms are not doctrine (acknowledged by the rest of the military or service) unless they are accepted into doctrine.⁸⁰

Mission Assurance (MA):

AFDP 3-10, Force Protection: Provides Air Force guidance on force protection, an element of Mission Assurance.⁸¹

JP 3-0, Operations: Describes force protection and associated responsibilities as an element of operations.⁸²

JP 3-12, Cyberspace Operations: Describes cyber operations as an element of both EMSO and mission assurance.⁸³

Planning:

JP 5-0, Joint Planning: Keystone publication for joint planning containing methodology used for all operations including DEMSO.⁸⁴

Annex 3-0, Joint Operational Planning Process for Air: Air Force planning guidance for

⁷⁶ Joint Pub 3-28. Defense Support of Civil Authorities. P ix.

https://www.jcs.mil/Portals/36/Documents/Doctrine/pubs/jp3_28.pdf

⁷⁷ AFDP 3-27 Homeland Operations. P 7. https://www.doctrine.af.mil/Portals/61/documents/AFDP_3-27/3-27-AFDP-HOMELAND-OPS.pdf

⁷⁸

https://www.doctrine.af.mil/Portals/61/documents/Doctrine_Primer/A%20Primer%20on%20Doctrine%208%20Oct%2020%20v2.pdf

⁷⁹ https://www.jcs.mil/Portals/36/Documents/Doctrine/pubs/cjcsi5120_02e.pdf?ver=DLjuWwZkfa7GNIwf5zNq0w%3D%3D

⁸⁰ DoD Dictionary. <https://www.jcs.mil/Portals/36/Documents/Doctrine/pubs/dictionary.pdf>

⁸¹ Air Force Doctrine Publication 3-10, Force Protection. https://www.doctrine.af.mil/Portals/61/documents/AFDP_3-10/3-10-AFDP-Force-Protection.pdf

⁸² https://www.jcs.mil/Portals/36/Documents/Doctrine/pubs/jp3_0ch1.pdf

⁸³ https://www.jcs.mil/Portals/36/Documents/Doctrine/pubs/jp3_12.pdf?ver=2018-07-16-134954-150

⁸⁴ JP 5-0 Joint Planning. P I-15.

https://www.jcs.mil/Portals/36/Documents/Doctrine/pubs/jp5_0.pdf?ver=ztDG06paGvpQRrLxThNZUw%3d%3d

installation commanders based on the joint planning process.⁸⁵

Chemical, Biological, Radiological, and Nuclear (CBRN):

MTTP-AFTTP 3-2.42, Multi-Service Doctrine for Chemical, Biological, Radiological and Nuclear Operations: Provides guidance for tactical CBRN, particularly Radiological and Nuclear events which overlap with DEMSO.⁸⁶

JP 3-41, Chemical, Biological, Radiological and Nuclear Response: Provides doctrine for domestic response to radiological or nuclear incidents. Military forces may conduct inter-organizational coordination and establish Memorandums of Understanding (MOU) before a disaster occurs in order to facilitate response. This doctrine states that training events and exercises with State and local entities are appropriate.⁸⁷

Intelligence:

JP 2-01, Joint and National Intelligence Support to Military Operations: Explains the role of intelligence in military operations, describes joint and national intelligence organizations, responsibilities, procedures, processes and support to joint operation planning.⁸⁸

AFDP 2-0, Global Integrated ISR Operations and Homeland Operations: Provides guidance on ISR in the homeland which includes DEMSO.⁸⁹

AFDP 2-0, Global Integrated ISR Operations JIPOE: Provides the Air Force intelligence process to include analysis of the threat (including EMP and GMD).⁹⁰

Electromagnetic Spectrum Operations (EMSO):

DoD Electromagnetic Spectrum Superiority Strategy (EMSSS): Puts forth the DoD EMS strategy which impacts DEMSO.⁹¹

AFDP 3-51, Electromagnetic Warfare and EMSO, Introduction to EMSO: Describes the Air Force approach to EMSO which converges with DEMSO.⁹²

JP 3-85, Joint Electromagnetic Spectrum Operations: Provides overview of electromagnetic environmental effects and their relation to joint functions, planning considerations, and execution and assessment of joint electromagnetic spectrum operations.⁹³

⁸⁵ Joint Operational Planning Process for Air. P 2. https://www.doctrine.af.mil/Portals/61/documents/Annex_3-0/3-0-D29-G-OPS-JOPPA.pdf

⁸⁶ <https://www.hsdl.org/?view&did=687919>

⁸⁷ JP 3-41 CBRN Response. https://www.jcs.mil/Portals/36/Documents/Doctrine/pubs/jp3_41.pdf

⁸⁸ https://www.jcs.mil/Portals/36/Documents/Doctrine/pubs/jp2_01_20170705v2.pdf

⁸⁹ Air Force Doctrine Publication 2-0, Global Integrated ISR Operations and Homeland Operations, https://www.doctrine.af.mil/Portals/61/documents/AFDP_2-0/2-0-D12-ISR-Homeland-OPS.pdf

⁹⁰ Air Force Doctrine Publication 2-0, Global Integrated ISR Operations Joint Intelligence Preparation of The Operational Environment, https://www.doctrine.af.mil/Portals/61/documents/AFDP_2-0/2-0-D06-ISR-Intel-Prep-Op-Env.pdf

⁹¹ https://media.defense.gov/2020/Oct/29/2002525927/-1/-1/0/ELECTROMAGNETIC_SPECTRUM_SUPERIORITY_STRATEGY.PDF

⁹² Air Force Doctrine Publication 3-51, Electromagnetic Warfare and Electromagnetic Spectrum Operations, https://www.doctrine.af.mil/Portals/61/documents/AFDP_3-51/3-51-AFDP-EW-EMSO.pdf

⁹³ JP 3-85. Joint Electromagnetic Spectrum Operations. https://www.jcs.mil/Portals/36/Documents/Doctrine/pubs/jp3_85.pdf

Appendix – B: Electromagnetic Countermeasures

Since electromagnetic events are complex by nature, it is important to understand that EMP affects different systems in different ways. Additionally, factors of latitude, ground salinity and local magnetic fields influence EMP magnitudes significantly. For those reasons, the severity of HEMP or GMD impacts may differ in Texas from those in Florida, Alaska or Maine. Although detailed analysis of every location is not feasible for every type of infrastructure, the detailed analysis for high-end critical components such as high-voltage transformers may be required to assess the risk and inform development of suitable countermeasures.

There are three primary pathways which electromagnetic energy travels:

- **Radiation** - Energy travels in electromagnetic fields through space or air directly from the source to the receiver.
- **Conduction** - Energy travels as induced currents and voltages in conducting materials. The magnitude of the induced currents is proportional to the length of the conductive line and energy can build up to hundreds of thousands of volts debilitating connected electrical and electronic systems including transformers, generators, communication/data facilities, and general consumer electronic systems. Examples of conductive materials include electronics power and signal cables, antennas, electronics power transmission lines, railroads and pipelines transporting water or fuel.
- **Geomagnetically Induced Current (GIC)** - Solar storm-caused magnetic field disturbances cause potential differences at the Earth's surface which can induce currents reaching thousands of amperes in long power and communication lines. These currents are referred to as GICs. Power utilities typically monitor GIC in real-time to inform operators of potentially hazardous conditions.

Additionally, electromagnetic waveforms are highly variable in duration, frequency spectrum, and amplitude. Waveforms affect infrastructure components differently depending on their specific electrical and physical characteristics. Countermeasure designs must be tailored to protect against the waveforms expected at the systems of interest. For example, a countermeasure that protects micro-circuits in a power grid substation would be ineffective at protecting the transformers in the same substation. Therefore, most vulnerable infrastructures require multiple forms of countermeasures to achieve comprehensive protection.

Most of the recent national effort to harden critical infrastructure to electromagnetic effects has been focused on solar GMD spurred by the 2011 NERC GMD Task Force and the 2016 Presidential Space Weather Executive Order 13744. More recently, within Presidential Executive Order 13865, nuclear EMP has been merged with space weather GMD under national electromagnetic security efforts. As result, there has been accelerated development of electromagnetic defense technology adapted for use across the whole of society. A general list of EMD countermeasures and their applications follows. Protection products and services are offered by many commercial vendors.

- **Shielding** - By far the most used electromagnetic defense countermeasure in both the private and public sectors. Often referred to as Faraday cages, their purpose is to create a closed barrier that occludes electromagnetic energy from interior systems. At the small-scale, Faraday cages are often used to store electronic devices such as radios, computers, data drives, etc. Large-scale Faraday cages may enclose an entire facility or large interior spaces within command-and-control centers, data repositories or other large structures housing sensitive electronic equipment and processes. Several companies have developed mobile Faraday cage structures the size of shipping containers which can be customized for multiple applications. Beyond the classic Faraday cage, other approaches to EM shielding include EMP blankets that can be used as temporary protection for things such as vehicles and generators. Other innovative solutions involve conductive cement and conductive concrete which can be used in new construction or retrofitted EMP protection for existing structures. Regardless of the form of shielding used, a crucial additional factor is protecting penetration points into the “container” such as communications, power, doors, or ventilation ports. Penetrations or other openings such as doorways, windows or vents must also be hardened against EMP energy, or the shielded container will be ineffective. Additionally, long-term surveillance and maintenance procedures must be in place to ensure future structural modifications and equipment upgrades do not compromise the original electromagnetic protection.
- **Filters** - Typically used at power lines, signal lines, and antenna termination panels, filters stop out-of-band destructive EM waveforms while allowing normal waveforms to pass. An example of technology under development, are filters that trap and attenuate unwanted EM energy from large power lines to protect transformers, generators and associated sensitive electronic components such as Supervisory Control and Data Actuation (SCADA) controls in substations and power plants. Another example is a filter insert between communications equipment and their antennas to prevent EMP from traveling from the antenna to sensitive electronic components. These types of filters allow for normal transmission and reception of intended frequencies. Advanced research is also underway to develop filters for high energy components like radars and other airspace management electronics that will ensure air transport availability during and after an EMP event.
- **Surge Protectors** - These limit the amplitude of EMP induced voltage spikes and thus divert the energy away from vulnerable components such as generators, transformers, controls, etc. This can be done by redirecting the voltage to ground or completely severing the connection to de-energize the circuit. While this creates a power outage across the circuit, it preserves key components which enables rapid restart or “black start” of the system post-event. In general, the reaction time of average household surge protectors is not fast enough to protect against an E1 pulse. That said, there are products available and under development with reaction times in the low nanosecond range to arrest the E1 and high-power microwave pulses.
- **Rapid Repair/Spares Kits** - Depending on the infrastructure, it may be more cost-effective to have repair and spare kits available for easily replaceable and low-cost items instead of comprehensively hardening those components. Examples include backup

electronics such as radios, cell phones, computers and easily replaceable components such as relays, fuses, switches and controls. To ensure their availability, spares must be kept in an adequately shielded environment. Where practical, pre-positioning spare components near the locations they are needed is recommended to avoid travel and resupply logistics delays. For extremely expensive components such as large transformers and generators, having spares on hand may not be economically feasible such that full EMP hardening is an option.